

ALPHA SERIES Rotational Viscometer

Instruction Manual

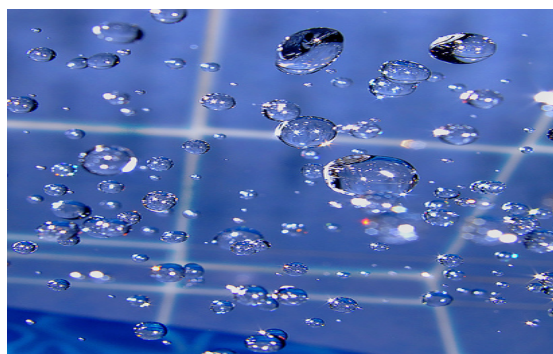

ALPHA SERIES

Rotational Viscometer

Software Version: 1.0

Instruction Manual

FUNGILAB, S.A.
C/ Constitució, 64 – Nau 15 – Pol. Ind. Les Grases
08190 Sant Feliu de Llobregat (Barcelona) SPAIN
Tel: +34 93 685 35 00
Fax: + 34 93 685 37 50
Email: sales@fungilab.com
www.fungilab.com

0. Table of Contents

0. Table of Contents	3
1. Introduction	4
2. Safety Instructions.....	4
1. Symbols used in this manual.....	4
2. Conditions for use.....	5
5. Maintenance	5
6. Equipment presentation	6
7. Equipment Description	8
7.1 Equipment set-up.....	9
7.2 The keyboard and screen.....	10
7.3 Start-up.....	11
7.4 Test-run	11
8. Menu system.....	13
8.1 The Main Menu	13
8.2 Configuration menu.....	13
8.2.1 Language (language change submenu).....	14
8.2.2 Units. (Unit change submenu).....	14
8.2.3 Calibration (Calibration submenu).....	15
8.2.3.1 Reset.....	16
8.2.3.2 Viscosity (Viscosity Calibration).....	16
8.3 Measurement Configuration	18
8.3.1 Measurement Screen.....	20
8.4 Information	21
9. Important Rheological Information.....	21
10. Accessories	26
10.1. Low viscosity adapters (LCP and LCP/B)	26
10.1.1 Mounting.....	27
10.1.2 Dismounting and clearing.....	28
10.1.3 Technical specification for LCP accessories	28
10. 2. Small sample adapters APM and APM/B.....	29
10. 2. 1 Assembly.....	29
10. 2. 2 Dismounting and Cleaning	30
10. 2. 3 Technical specifications of APM and APM/B.....	30
10.3 HELDAL UNIT – Helicoidal Movement Unit	31
10. 3. 1 Helder unit mounting.....	32
11. Model/Spindle correspondence tables	34
12. Model/Spindle/Oil calibration tables	36
Table 8. ALPHA L standard spindle selection	37
Table 9. ALPHA L Special spindle selection.....	38
Table 10. LCP Adaptor with ALPHA L.....	39
Table 11. ALPHA R Standard spindle selection.....	40
Table 12. ALPHA R special spindle selection.....	41
Table 13. LCP Adaptor with ALPHA R	42
Table 14. ALPHA H standard spindle selection.....	43
Table 15. ALPHA H special spindle selection.....	44
Table 16. HELDAL's special spindle selection for ALPHA L.....	45
Table 17. HELDAL's special spindle selection for ALPHA R	46
Table 18. HELDAL's special spindle selection for ALPHA H.....	47

1. Introduction

Thank you for acquiring the ALPHA rotational viscometer model from Fungilab, SA.

The ALPHA is a rotational viscometer, based on the measurement of the torque of a rotating spindle in a sample at a specified velocity. Three different models, as well as various accessories, allow it to cover a wide range of viscosity measurement.

2. Safety Instructions

- It is not the purpose of this manual to outline all of the safety instructions recommended for the use of the rotational viscometer, its accessories, and samples. It is the responsibility of the user to establish health and safety practices and to determine the application's limits before use.
- Fungilab, S.A. guarantees the satisfactory operation of the viscometers and its accessories only if there have not been any unauthorized adjustments to the mechanical pieces, the electronic components, and the software.
- The operator should follow all of the warnings and instructions of this manual to ensure the safe and proper operation of the equipment.
- Do not use the equipment for any other purpose that is not described in this manual.
- Do not use any accessory that is not supplied and approved by Fungilab, S.A.
- Do not use the viscometer or its accessories if there is any suspicion of malfunction. Do not use the equipment in situations or conditions that can provoke personal injuries or material damage.

The rotational viscometer is **not** an inflammable, non-hazardous instrument and therefore should not be used in areas where there is an explosion risk.

Before using the viscometer, carefully read and observe the following precautions: those who do not follow them may cause serious harm or personal injuries.



To avoid an electric shock:

- Do not use the rotational viscometer without a solid connection to the ground.

3. Symbols used in this manual

The following symbols are used in this instruction manual:



This symbol warns us of an operational, practical, or similar procedure that, if it is not carried out properly, may damage the equipment.

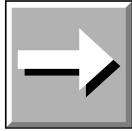

This arrow indicates additional information that should be used by the user.



This symbol warns us of an operational, practical, or similar procedure that, if it is not carried out correctly, may irreparably damage the equipment. Do not proceed further unless the indicated conditions are fulfilled and have been perfectly understood.

4. Conditions for use

- Indoor use
- Maximum altitude 2000 m.
- Surrounding temperature range: from +5 to 40°C
- 80% maximum relative humidity for up to 31°C, and going as low as 50% of relative humidity for up to 40°C.
- The power source fluctuations should not surpass $\pm 10\%$ of the nominal voltage
- Installation category II
- Pollution level II

5. Maintenance

- Always clean all of the parts after each use! Clean the spindles and the spindle protector well, and then immediately dry them. Make sure that there is not any sample remaining especially in the delicate zones like the spindle connector.
- Detergents or solvents to clean the spindles and the protector:
 - For food samples, use lukewarm water and if necessary, use soft detergents (like those which are used at home)
 - Other solvents that generally give good results are acetone, gasoline, or something with a high percentage of alcohol
 - If you use any other solvent, make sure that it does not corrode the spindles or the protector. The spindles are made in AISI 316.

Warning: Handle the volatile and inflammable solvents with extreme care. It is the user's responsibility to establish safety conditions at work.



- Regularly check the spindle's thread and the viscometer shaft.
- During the working life of the viscometer, the equipment will require certain check-ups. In this case, please contact the local distributor.
- Regular maintenance is important. We recommend an annual check-up by the service technician of your local distributor.

6. Equipment presentation

- When the equipment package is received, verify and confirm the delivery note. If some discrepancy or problem is found, immediately notify the supplier.
- Check that the model corresponds to the equipment that was ordered.
- Carefully read the use instructions.
- All modifications, eliminations, or lack of maintenance of any of the machine's mechanisms, defy directive 89/655/CEE and the manufacturer is not responsible for any damages that may result.

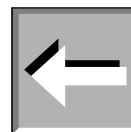

In the attached photograph (Figure 1) you see the position of each piece inside the equipment's carry-case. Please, keep the carry-case in a safe location. In the case of needing to transport the equipment or store it for a long period of time, always use the carry-case by placing each part as shown in the drawing. In the case of incorrect packing, where any of the pieces of equipment could suffer some damage, this damage will not be covered by the manufacturer's guarantee. FUNGILAB recommends using the carry-case provided with the equipment for making any kind of delivery.



Parts included with the equipment for standard delivery:

- Viscometer head with serial number
- Foot or base, 3 height adjustable knobs for the base
- Nut
- Indented rod
- Standard spindles
- Spindle protector
- Spindle support
- Power cable
- Calibration Certification
- Instruction manual

Standard spindles

Model L: L1, L2, L3, L4

Models R y H: R2, R3, R4, R5, R6, R7



Fig 1. The viscometer in its carry-case
(To be requested as accessory)



Fig. 2 The viscometer in its standard packagain

7. Equipment Description

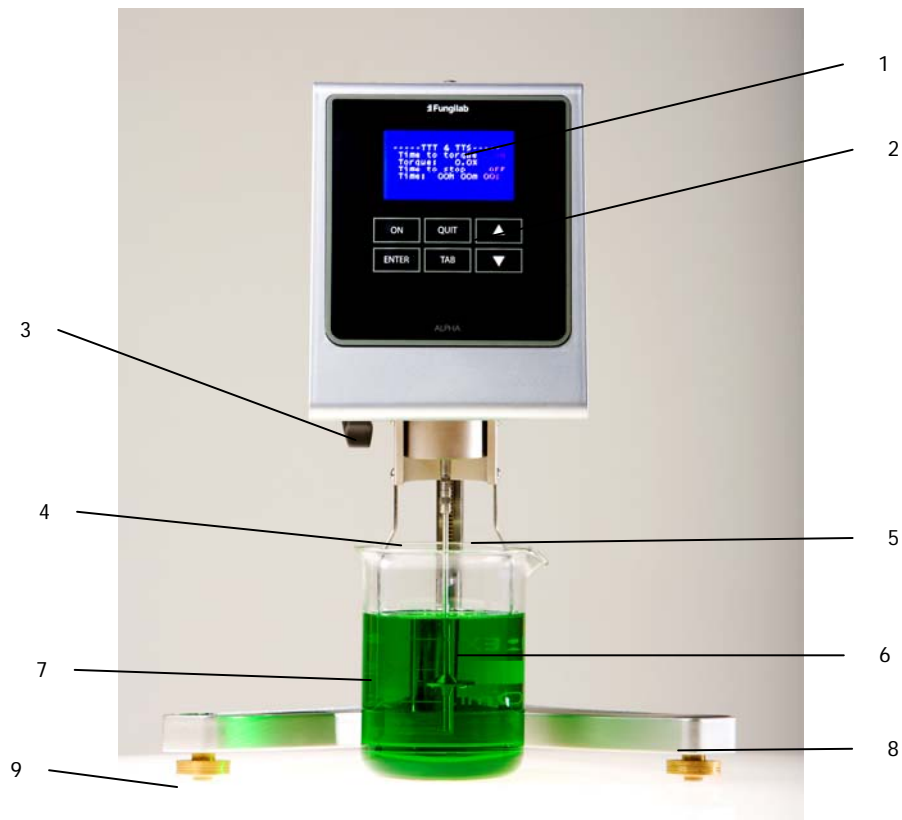

Fig. 3 Frontal view of the equipment

1. Screen
2. Certified keyboard
3. Nut
4. Spindle Protector
5. Fastening rod
6. Spindle
7. Sample container (not included)
8. Base (viscometer support)
9. Height adjustable knob



Fig.4 Back view of the equipment

1. Serial number label
2. Switch
3. Feeder cable slot

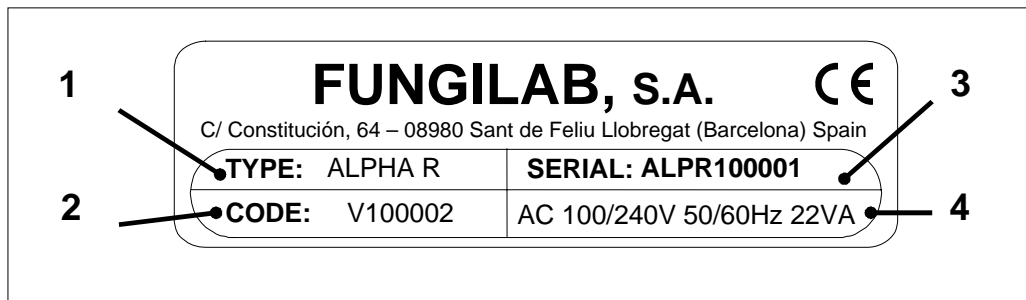

Fig. 5. Equipment identification label

Description of the equipment identification label:

1. Viscometer model
2. Viscometer code
3. Serial number of the equipment
4. Voltage, frequency, and power of the equipment

7.1 Equipment set-up

- Remove all of the parts from the carry-case. Note the figure below (fig 6).
- Correctly place the three height adjustable knobs (B) on the Y-shaped base (A).
- Mount the fastening rod (C) with the holding screw (D) at the base (A).
- Attach the nut (F) to the fastening rod. The viscometer should be connected to the nut (F) by means of its rod (E).

Note:

The following process should be done carefully in order to harm to the shaft of the viscometer. Immediately remove the shaft's plastic protector before beginning to use the viscometer.



- Insert the horizontal rod of the viscometer (E) into the nut (F).

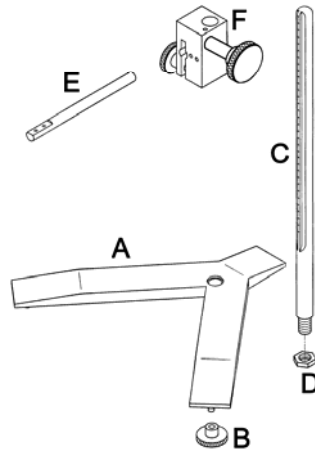

Fig. 6 Set-up for the viscometer base

- The viscometer should be placed on a stable laboratory table or on a stable surface free of vibrations (i.e. caused by other machines or equipment). Do not put the viscometer in direct contact with sunlight or in the middle of any air flow (the temperature of the sample can be easily influenced by the surrounding conditions). The viscometer has been designed to work indoors!
- Turn the height adjustment knobs until the height of the viscometer (located in rod E) is correctly adjusted.
- Plug the power cable into its correct slot located on the back of the equipment (Fig. 3 position 4) and plug it into the power source.

WARNING:

The socket by which the viscometer will be connected should have a ground. Always use a power cable with a ground connection! Verify that the voltage and the frequency coincide with the specifications for the viscometer (look at the identification label Fig. 4, for more information). Before turning on the machine, let it sit for some time so that it acclimates to the surrounding temperature in order to avoid a short-circuit caused by condensation. The fluctuations of the power source should not surpass $\pm 10\%$ of the nominal voltage.



7.2 The keyboard and screen

Before starting up the machine, one should become familiar with the viscometer controls seen in the previous section. The instrument has a 6 key keyboard (Fig. 7) and a 4-lined Vacuum Fluorescent Display screen (number 1 Fig. 3) on the frontal part ready to use and they allow the user to interact with the machinery. The screen always shows the operations that the user is carrying out by showing menus that will be explained later on. The measurements collected by the instrument will also be explained in this manual. The keyboard gives the user the mobility throughout all of the menus, the selection of different options, and the creation and/or modification of viscosity measurement configurations to suit the user's needs.

The keyboard has the following configuration:



Fig. 7 The keyboard for the ALPHA viscometer

The different numbered keys will always allow you to type in the proper numerical value (if a modifiable field has been selected).

Tecla	Función
'Δ'	Go to the previous option; increase a value when a field has been selected..
'∇'	Go to the next option; decrease a value when a field has been selected.
'TAB'	Field select change in some menus.
'QUIT'	Return to previous screen. Motor stop during measurements.
'ENTER'	Accept an option or value in a field. It also allows editing to fields that can be modified.
'ON'	Stop/Start the motor during measurements.

In the following sections, the function of each key in the corresponding menus will be explained in full detail, including the exceptions to the general operation.

7.3 Start-up

Turn on the switch on the back of the machine (number 2, Fig. 4). If after doing this, the machine does not turn on:

- Verify that the power cable is connected to the equipment (back part, number 3, Fig. 4) and that the power cable is connected to the power.

The machine will beep, indicating that it has started and it will show the following screen:

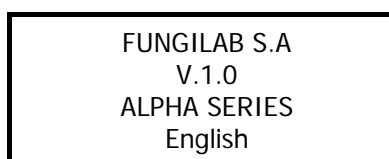

The screen informs the user of the version and the instrument model in addition to the selected language. After a few seconds, the Start-up screen will disappear and the Main Menu screen for the viscometer is shown (section 8.1 of this manual).

The equipment initially comes configured with:

- English
- Temperature units in Celsius (°C)
- Viscosity units in centipoises (cP).

If these are not the desired basic configurations, the equipment can be configured and changed to meet the user's needs. The method of configuring the apparatus by varying these and other parameters is explained in detail in a later section of this manual called 'Configuration menu' (section 8.2). Any changes made to the machine will stay configured to the last modification made at the configuration menu and will not return to the factory settings after a restart.

Once the configuration information is given will submit the system to a Autotest.

7.4 Autotest

The Autotest menu allows you to verify the operation of the viscometer in a way that allows detection of motor malfunctions in a simple and practical way.

The following message will appear on the screen:

AUTOTEST
Remove the
Spindle and
Press <ENTER>

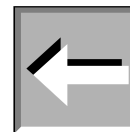

VERY IMPORTANT: The Autotest should be carried out without a spindle.

Once this message is shown on the screen, we should confirm that the spindle is not connected. Afterwards, press 'ENTER' and the auto-check process will begin. While this test is running, the screen will show this message:

Testing
...

The dots that appear below the Word "Testing" will continue to appear and reappear in a progressive manner every half second.

If the Autotest is allowed to finish, two possible messages will appear, depending on the type of diagnostic test that was run.

If the instrument detects an anomaly, it will show the following message on the screen:

AUTOTEST ERROR
The system is not
working properly,
press <ENTER>

If this message appears, the machine will let off a whistle and a service technician from the supplier or manufacturer should be contacted. To get the manufacturer's contact information, press the <ENTER> key and it will appear in the following format.

TECHNICAL SERVICE
FUNGILAB, S.A.
+34 93 685 35 00
www.fungilab.com

If it is a system error, the equipment will stay blocked, meaning the motor will not function. If the machine is turned off and restarted, the same screen will reappear.

In the case of a successful check, the machine will beep once it is finished and the main menu, as shown below, will appear.

> Instrument Setup
Measurements
Information

8. Menu system

8.1 The Main Menu

Fungilab viscometers work with a simple system of menus that allow the user to go through the instrument in a quick and simple way. The basic actions in the menus are: moving through the options ('Δ' and '∇' keys), selecting an option ('ENTER' key) or returning to the previous menu ('QUIT' key).

The main menu is the one that appears after the opening screen. It is accessed by turning on the machine normally, and after a satisfactory result from the test run.

The main menu screen will show:

```
> Instrument Setup
  Measurements
  Information
```

By default, the cursor '>' is placed on the 'Instrument Setup' option.

The menu can be navigated with the 'Δ' and '∇' keys, with which you select the desired option and press 'ENTER', which takes the user to the desired submenu (for more information about each function in particular see the corresponding sections).

The first time the machine is used, it is advisable to access the 'Instrument Setup' option as the first step in order to establish the values for certain parameters of the viscometer such as language and measurement units.

In the following sections, each of the 3 submenus of the main menu can be seen beginning with the configuration submenu.

8.2 Configuration menu

The configuration menu contains those functions that are not standardized and that modify the state and/or operations of the instrument. Once the 'Instrument Setup' option is selected by pressing the 'ENTER' key, the following screen will appear:

```
---Instrument Setup---
>Language
  Units
  Calibration
```

Move through the options using the 'Δ' and '∇' keys and select a submenu with the 'ENTER' key.

The main menu provides the possibility of:

- Changing the working language
- Selecting the measurement units (viscosity and temperature)
- Carrying out calibrations (the machine comes calibrated from the factory, therefore it is not necessary to do any calibrations when the machine is received)

The language, time, and units should be selected by the user before beginning to work with the equipment so that it functions properly.

8.2.1 Language (language change submenu)

Once the configuration menu has been accessed, the first option that the cursor '>' points to is 'Language'. To make a change to the language, this option must be selected by hitting the 'ENTER' key.

When we enter in this submenu, the viscometer will show a screen like the following one:

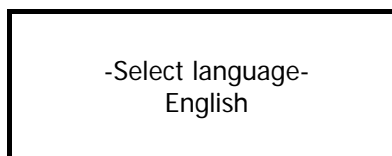

By using 'Δ' y '∇' the different working languages for this equipment can be seen, which are:

English
French
German
Italian
Japanese
Portuguese
Spanish
Dutch
Polish
Catalan

Once the language has been selected, press 'ENTER' and it will automatically change the language of the menus and return to the configuration main menu screen.

8.2.2 Units. (Unit change submenu)

The ALPHA-type viscometer allows the user to select the units that are used for measuring viscosity.

And those of dynamic viscosity are:

- International system of units (Pa·s or mPa·s)
- Centimetre-gram-second system of units (Poise or centipoises)

When the cursor key, '>', points to the units submenu, it can be accessed by pressing the 'ENTER' key and the viscometer will show the following screen:

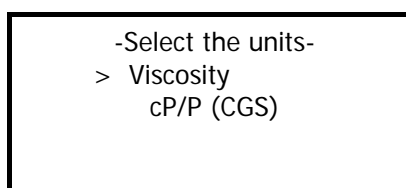

By default, this submenu screen for 'Units' comes configured with the viscosity unit's field selected.

Once the desired field has been selected, the units to be used with the viscometer can be varied viscosity, by using the 'Δ' y '∇' keys to switch the options.

After the desired units have been selected, press the 'ENTER' key to save the changes and return to the configuration main menu screen.

8.2.3 Calibration (Calibration submenu)

This submenu contains the viscosity calibration options that the user can exploit to recalibrate his equipment.

IMPORTANT:

The viscometer contains a default calibration element, which is installed during the manufacturing process. It is for this reason that it is unnecessary to calibrate the equipment when using it for the first time. Nevertheless, certain norms of quality recommend that the equipment be recalibrated once a year, which is why we offer the user the possibility of realizing this calibration without needing to send the viscometer back to the usual provider, or to FUNGILAB.

FUNGILAB, S.A. cannot be held responsible for the measurements taken by an independently recalibrated viscometer, and it is essential to follow the instructions given by Fungilab to the letter when recalibrating.

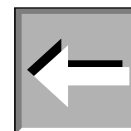

Calibration Norms:

- To execute a viscosity calibration it is necessary to have on hand at least a little standard calibration oil and a thermo statization system to maintain the sample at a constant temperature. If you do not possess this equipment then you will not be able to guarantee good post-calibration measurements. FUNGILAB, S.A. provides upon request the standard oils necessary for the calibration, as well as the accessories need to thermo-statize the oils.
- There are two types of calibration:
 - Calibration of reference spindle: These spindles are coaxial spindles, with which the accessories APM or APM/B must be used. By calibrating these spindles, you're changing the calibration of all of the viscometer's spindles. Reference spindles:

▪ Model L	TL7
▪ Model R	TR11
▪ Model H	TR9
 - Calibration of the rest of the spindles: The calibration of any spindle, which is different from the reference spindle, will only modify the values of that individual spindle. The rest of the equipment's spindles will not be affected by this calibration. If you want to calibrate more than one spindle and you don't do it with the reference spindle, the spindles will have to be calibrated one by one. The oils used for each spindle will also be different, so for calibration you should have standard silicon oil for each spindle you're calibrating.
- Tables 5 and 6 (page 37) specify the standard oils necessary for each spindle.

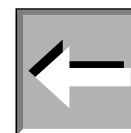

This submenu is accessed through the main configuration menu, by choosing the Calibrate menu and pressing 'ENTER'. Once at the submenu, the following screen will appear:

```
----Calibration----  
> Reset  
  Viscosity
```

Using the 'Δ' and '∇' keys, you can select the different options of this submenu, placing the '>' cursor over each option and pressing 'ENTER' to chose it.

8.2.3.1 Reset

This submenu contains the equipment's RESET option.

Resetting the equipment's configurations implies recuperating the different calibrations present in the equipment at the factory stage. Thus, after resetting, the equipment will recuperate the original viscosity calibration.

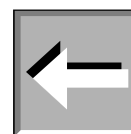

Upon entering this submenu, the following screen will appear:

```
WARNING:  
RESET THE EQUIPMENT  
<ENTER> <QUIT>
```

If you want to continue with this process, press 'ENTER' and you will be brought to the following screen.

Once the 'ENTER' key is press, a second confirmation will be solicited by way of a security measure. The following screen will appear:

```
Are you sure?  
<ENTER> <QUIT>
```

If you press 'ENTER' here, the factory-stage calibration will be restored (calibration, language), the memory will be erased as well as the programming and you will return to the main configuration screen.

8.2.3.2 Viscosity (Viscosity Calibration)

If you select the viscosity option (moving through the menu with the 'Δ' and '∇' keys and press 'ENTER' you will access the following screens, depending on the model of your viscometer:

Model L

```
Spindle L1
v 100.0 cP
```

Models R and H

```
Spindle R1
v 100.0 cP
```

The list of possible spindles to use depends on the model of your viscometer (L, R or H). Thus, in tables 8 through 18 (page 38 on) you can see the different spindles available for each model.

Once this field is selected and situated in the list of corresponding spindles, you can select the spindle that you wish to calibrate using the 'Δ' and '∇' keys.

Once the spindle is selected, go to the "Viscosity" field using the 'TAB' key. Pressing 'ENTER', accept the field and introduce the value of the standard oil corresponding to the viscosity calibration. To introduce the data, use the 'Δ' and '∇' keys to increase or decrease the value of each digit. Then press 'TAB' again to go from one digit place to another.

Once the value of the oil is determined, press 'ENTER' to continue with the calibration process

Next, press the 'ON' key and the following screen will appear:

```
Attach the
spindle and
press <ENTER>
```

Once the spindle is in position in the device, press 'ENTER' again and the following screen will appear:

```
Delay time:
00h 00m 00s
```

In this screen it is necessary to introduce the time required from the moment you give the command to start the calibration to the moment the device begins the calibration process. This time lapse is frequently used to allow the whole of the sample and spindle to arrive at thermal stability before starting the actual calibration.

NOTE: When the digits of this field are not selected, the whole line will be blinking. When the field is selected using the 'ENTER' key, only the place of the digit to be modified will be blinking

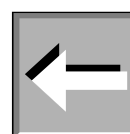

The field will be permanently open to modification. To modify the value, use the 'Δ' and '∇' keys to increase or decrease the value of each digit. Then press 'TAB' again to go from one digit place to another. By pressing 'ENTER' again, you can finalize the field modification and start the calibrating process by pressing 'ON'.

Pressing the 'ON' key will start a countdown back to zero.

The spindle must already be submerged in the liquid once you confirm the start time.

When the countdown gets to zero, the viscometer will start the calibrating sequence. While the equipment is calibrating, the following screen will appear (example):

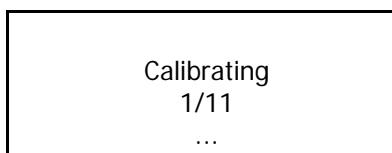

On this screen, each step of the calibrating process is displayed.

When the process is over, information on the values of the angles and linearity of the calibration are displayed.

The exit key 'QUIT' allows us to exit to the main but never while calibrating (never while the screen looks like the example just above).

NOTE: *Exiting mid-calibration denies the equipment a proper calibration and therefore it cannot guarantee accurate results.*

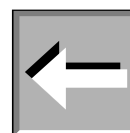

8.3 Measurement Configuration

The measurement configuration menu allows access to the basic functions of the device: measuring fluid viscosity. From the main menu screen, with the '>' cursor over the 'Measurements' field, hit the 'ENTER' key to choose this option.

After choosing this option, you will see one of these screens, depending on the model viscometer you have:

Model L

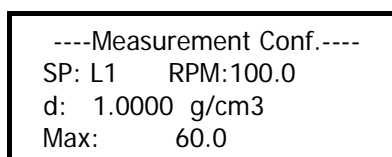

Model R and H

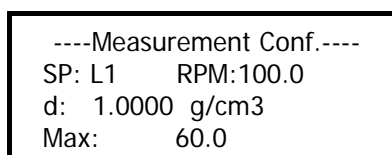

To move through the fields cyclically use the 'TAB' key and with the 'ENTER' 'Δ' and '∇' keys you can proceed to edit each one of the fields. Let's first look at what each field represents and how to modify it.

- SP: the field that indicates which spindle we use for the measurement.
- RPM: the field indicating the working speed.
- d: indicates the density of the sample
- Max: Maximum viscosity to be determined with the speed and the spindle selected.

The SP field together with the selected speed will determine the maximum and minimum viscosity values (from 8 to 18, from page 38, on), as well as the existence of a shear stress measurement (if you're using coaxial spindles). To modify the spindle, you first need to select the field using the 'ENTER' key. The viscometer will only show the spindles that are compatible with your model. Once the spindle field is selected, we use the same direct selection method previously explained in the section about viscosity calibration.

IMPORTANT: *Selecting a spindle that doesn't correspond to the ones adapted to your model will cause measurement problems.*

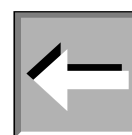

The RPM field (revolutions per minute) indicates the speed at which the test will be done. The ALPHA series incorporates 18 pre-determined speeds: 0.3, 0.5, 0.6, 1, 1.5, 2, 2.5, 3, 4, 5, 6, 10, 12, 20, 30, 50, 60, 100 rpm.

The viscosity of the liquid and the spindle used determine the speed (refer to tables 8 to 18).

Speed modification: once the corresponding field is selected using the 'TAB' key, you can move through the pre-established speed using the 'Δ' and '∇' keys. If you want to keep the selected speed, press the 'TAB' key to change parameters.

You also have a quicker option of changing the speed. When the speed field is selected (it will be blinking), hit the 'ENTER' key to access this option. All of the digits will be blinking and you can modify them according to your needs. Using the 'Δ' and '∇' keys, you can modify each digit, cyclically, between 0 and 9. The ',' will be used as a decimal market. If two commas are accidentally entered, the value will be considered invalid and thus will not be saved. At this time, you would have to repeat the process. To change the digits you use the 'TAB' key and to confirm the entered value (as long as it is a coherent and valid one), press 'ENTER' again.

These options are not exclusive, meaning that you can use the speed edition mode to modify the speed and then change it again using the 'Δ' and '∇' keys to choose a speed that is closest to the desired speed amongst the predetermined equipment speed.

NOTE: *If, during modifications, you introduce a speed that doesn't exist amongst the pre-programmed speeds, the machine will automatically replace your introduced speed by the closest one to it amongst the pre-determined speeds.*

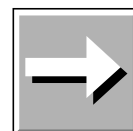

If, once the values of all of the fields are confirmed, you press the 'ON' key, you will go on to the measurement screen. If instead you press the 'QUIT' key, you'll return to the main menu screen, losing all of the data introduced in measurement configuration.

8.3.1 Measurement Screen

You can access this screen by pressing the 'ON' key after the introduction of the measurement parameters. The viscometer will start moving the spindle, which means that the equipment is ready to start collecting data. We will now see an example of the data presented on screen at this stage:

```
-----Measuring-----  
SP: L1  RPM:100.0  
V: 30.4 cP  
50.1 %
```

As the equipment goes about collecting viscosity data (one piece of data for each rotation of the spindle), the information on the screen will be updated. On the screen you will see:

- SP: Current spindle. Selected on the previous screen.
- RPM: Revolutions per minute. Value selected on previous screen.
- V: Viscosity. Value expressed in cP or mPa·s, or cSt (in the case that a density different from the default one is introduced).
- %: Certain percentage of the base scale. Percentage value of the curvature of the spring in relation to the base of the same scale.

NOTE: The speed field will be blinking until the motor speed is stable.

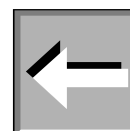

NOTE: Depending on the selected speed, it is possible that the speed reading will take a few seconds or minutes to appear. It's important that the viscometer has made at least five rotations (which equals five measurements) before considering the measurements to be valid, as the device needs that time to stabilize. It's also important to only take into account the temperature of a stable sample.

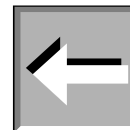

In addition to visualizing measurements made on the sample, the user can also do other things from this screen.

Using the 'Δ' and '∇' keys, you can increase or reduce the speed of the spindle's rotation (RPM). When you press one of these two keys, the rotation speed increases ('Δ') or decreases ('∇'), respectively, from the previous speed.

This way, we can comfortably modify the turning speed without having to leave the measurement screen.

When you make a speed change, the field will start blinking again until the motor speed stabilizes.

To make a unit change, whether it's in viscosity or in temperature, the equipment will have to take into account the stabilized rotation (speed field (RPM) not blinking). With the 'TAB' key, the viscosity field will blink for five seconds. If you then use the 'Δ' and '∇' keys, you can vary the units. To save the changes, press 'ENTER'. If you do not do this within five seconds the changes will go unsaved. The units in the temperature field can be modified using the same process but you will have to use the 'TAB' key again when you've selected the viscosity field (it will be blinking).

IMPORTANT: When the certain percentage of the base scale is lower than 15% or is as high as 100%, the measurement cannot be considered valid and

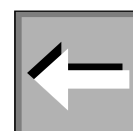

the equipment will emit a warning beep with every rotation made under these circumstances.

With the 'ON' key you can stop or start the motor, which allows for momentary pauses in an experiment. When you press this key, the equipment will show the following message:

Motor stop

If you press the 'QUIT' key when you see the message above, the viscometer will abandon the measuring and return to the main screen.

If you press the 'ON' key, the equipment will restart the measurements with the same configuration.

8.4 Information

If you select the 'Information' option, you will be brought to a screen in which the contact information of the manufacturer will be displayed, resembling this:

Fungilab
Tel: 34 93 685 35 00
sales@fungilab.com
www.fungilab.com

This option is incorporated as a means of security in the case of loss of the present document or the displacement of any reference to the company in technical support or on paper.

9. Important Rheological Information

To obtain precise results it is necessary to know the most important rheological properties of the sample.

Newtonian fluids

The viscosity of these fluids does not depend on the shear rate meaning that at any speed the viscosity is the same. Only temperature affects the viscosity; changes of 1°C can provoke a change in the viscosity of up to 10%.

Non-Newtonian fluids

The viscosity of this type of products changes with the speed variable. Due to this inconsistency, the term *Apparent Viscosity* is habitually used.

Within the classification you can find two different groups:

Time-independent non-Newtonian fluids
Time-dependent Newtonian fluids

Time-independent non-Newtonian fluids

The viscosity of a time-independent non-Newtonian fluid depends on the temperature and the speed gradient.

Pseudo plastic Fluids:

The viscosity diminishes when the speed gradient increases.

Practical examples: paints, shampoos, fruit juice concentrate, adhesives, polymers, grease, starch, etc.

Dilatants-Fluids:

The viscosity increases with the speed gradient.

Practical examples: clay, sweets components, etc.

Plastic Fluids:

These fluids only start to flow after having been submitted to a certain force (shearing force). They behave like solids in static conditions.

Practical example: Ketchup.

Time-dependent non-Newtonian fluids.

The viscosity of time-dependent non-Newtonian fluids is dependent on the temperature, on the speed gradient and on time.

Tixotropic fluids:

In these substances the viscosity diminishes with time when the fluid is subjected to a constant speed gradient. These substances tend to return to their previous viscosity once the speed gradient ceases to be applied.

Practical examples: Many products in industrial food production (yogurt, etc.)

Reopectic fluids:

In these fluids, the viscosity increases with time when the fluid is subjected to a constant speed gradient.

These substances tend to return to their previous viscosity once the speed gradient ceases to be applied.

These fluids are not very common.

NOTE: *The turbulent behaviour of a fluid can produce falsely high results in viscosity tests. Normally, turbulent behaviour is due to an excessively high rotation speed in relation to the viscosity of the sample (see detailed Warning further on).*

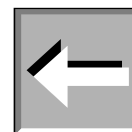

FACTORS AFFECTING VISCOSITY

There are many variables that affect the rheological properties of products, so it is very important to take the following factors into account.

Temperature

Temperature is one of the most obvious factors affecting rheological behaviour.

It is essential to consider the effects of temperature on viscosity in the evaluation of materials that are subject to changes in temperature during its use or other processes. Some examples of this are motor oils, greases and adhesives.

Shear Rate

When a fluid is subjected to variations in the speed gradient during its process or use, it is essential to know its viscosity at the projected speed gradients.

Examples of materials, which are subjected to and affected by important variations in speed gradient during its process or use, are: paints, cosmetics, liquid latex, some food products such as ketchup, and blood in the human circulatory system.

Measurement conditions

The measurement conditions of a material during its viscosity reading can have a considerable effect on the results of this measurement. Consequently, it is important to be careful and control the environment and conditions of any sample subjected to analysis.

Variables such as the type of viscometer, the speed/spindle combination, the sample's container, the absence or presence of a spindle protector, the temperature of the sample and the sample preparation techniques, etc, can affect not only the precision of the reading but also the real viscosity of the sample.

Time

Ageing under the same speed gradient conditions affects tixotropic and reopectical fluids. In some fluids the action of time combined with the proportion of the shear is very complex. In these cases, one can observe, with time, a return to the original fluid state.

Previous conditions

The conditions that the sample is subjected to before the viscosity reading can significantly affect the results, especially with heat-sensitive fluids or ageing.

Thus, the storage condition and the sample preparation techniques should be conceived to minimize effects on the viscosity measurements.

Composition and additives

A material's composition is a determining factor in its viscosity. When the composition is altered, whether this is by changing substance proportions that compose it or adding other substances, important changes can be observed in their viscosity.

For example, adding solvent to printing ink reduces the viscosity of the ink, and other types of additives are used to control the rheological properties of paints.

VISCOSITY MEASURING PROCEDURES

Data history

We recommend documenting the following information each time you take a viscosity measurement:

- Model or type of viscometer
- Spindle (and accessory)
- Rotation speed
- Sample container
- Sample temperature
- Sample preparation procedure (if existent)
- Spindle protection use

The process is necessary in the event of comparison of results with other organizations, in the interest of being able to guarantee the possibility of reproduction of the results obtained.

The spindle and its protection

Examine each spindle before using it. If it's damaged or eroded in such a way that its dimensions are changed, it will provide false results for your viscosity reading.

The spindle protector (provided with every Fungilab rotational viscometer) protects the spindle and the viscometer axle, and it is important for the reading of low viscosities with standard spindles.

The protector should always be used. In the event that it is not used, its absence must be reported in the measurement procedure notes.

The protector isn't used with most of the accessories.

Speed selection and spindle

If there is no described work procedure, the best method for the selection of the spindle for each speed is "trial and error". The objective is a torque reading between 15 and 95%, according to the type of product in question, and a percentage higher than 50% is recommendable.

If you know the fluid's approximate viscosity, the quickest spindle/speed selection method is referring to the tables of maximum approximate viscosity.

When you do tests at different speeds, you should select a spindle with which all of the speeds show a torque reading of between 15 and 95%

GENERALLY:

RPM INCREMENT \Rightarrow READING PRECISION INCREMENT

SPINDLE SIZE-REDUCTION \Rightarrow READING PRECISION INCREMENT

(Except for the non-Newtonian fluids that change their viscosity value when the rotational speed is modified. In these cases we recommended measuring with a determined speed and using a comparison method.)

Size of the sample container

For measurements using the Fungilab viscometer, we recommend working with containers with an interior diameter of 83 mm or more. The usual container is a 600 ml precipitation vase.

If a smaller container is used, the viscosity values could be greater, especially with low-viscosity fluids.

Sample conditions

The sample should be free of air bubbles.

It should be exposed to a constant and uniform temperature. Before doing the viscosity readings, make sure that the spindle and its protection are the same temperature. Usually, thermostatic baths are used to maintain the sample at the desired temperature.

The sample should have the properties of a homogeneous liquid; this means that it cannot have particles capable of being precipitated, deformed by the shear rate or decomposed into smaller particles.

The measured substances shouldn't be subject to chemical or physical changes during the measurement.

Other essential conditions

Experiments in conditions in which turbulent behaviour can be encountered should be avoided.

The condition should be that of stationary fluid. Accelerations or retarding processes are excluded from the parameters of measurement.

Spindle immersion

The standard spindle should be submerged to the halfway mark in the axle. An erroneous immersion can compromise the result of the viscosity measurement.

With the disc spindles you should avoid the creation of air bubbles, which could remain under the disc. To this end you should insert the spindle laterally and smoothly, and bring it over to the centre of the sample. Once it is there, attach it to the viscometer's axle.

Precision and Repetition

FUNGILAB viscometers guarantee a precision of $\pm 1\%$ from the bottom of the speed/spindle combination scale, and a repetition of $\pm 0.2\%$.

Getting a viscosity reading

Before working with the viscometer you should make sure of the following points:

The viscometer is properly fastened to the stick and level.

Both spindle and speed are selected. (read attentively the section about speed and spindle selection).

The spindle is carefully placed and fastened.

The instructions and necessary parameters for obtaining a viscosity reading have been carefully read in the user's manual.

Once the readings have been initiated, allow some time for stabilization, the length of which will be in function of the rotational speed during the measurement.

IMPORTANT WARNING

When you wish to obtain viscosity reading with FUNGILAB rotational viscometers, there are two considerations to take into account:

The obtained viscosity results must be between 15% and 100% of the torque range, for whichever spindle/rotational speed combination.

The viscosity reading must be executed under laminar flow condition, not turbulent flow conditions.

The first consideration is linked to the precision of the instruments. All of the FUNGILAB rotational viscometers guarantee a precision of (\pm) 1% from the bottom of any spindle/rotational speed combination scale.

Working with less than 15% of the bottom of the scale is not recommended due to that the potential (\pm) 1% error in the viscosity is relatively big compared to the equipment reading.

The second consideration has to do with fluid mechanics. All of the rheological measurements of fluid flow properties must be taken under laminar flow conditions. Laminar flow is when all of the movements of the fluid particles are in sheets, directed by an external applied force.

The flow lines represent speed and fluid flow direction.

Laminar flow: "straight" flow lines. Relatively easy to predict. Generally slow.

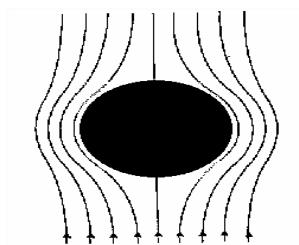

Turbulent flow: "non-linear" flow lines. Impossible to predict the exact movement of the fluid. Very quick.

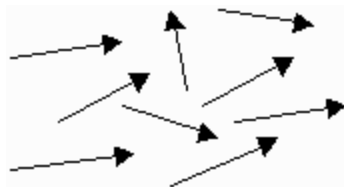

For rotational systems, this means that the fluid's movement must be circumferential. When the internal forces of a fluid end up being too great, the fluid can become a turbulent flow, in that the particles that make it up become unpredictable, making it impossible to analyse it with standard mathematical models.

This turbulence creates a false reading which is a lot higher than the real one, without linear growth and totally unpredictable.

For the following geometries, these transition points have been found to be approximate to turbulent flow:

- 1) Spindle L1: 15 cP to 60 rpm
- 2) Spindle R1: 100 cP to 50 rpm
- 3) Adaptor LCP: 0.85 cP to 60 rpm

Turbulent flow conditions will always exist in these conditions as long as the RPM/cP ratio exceeds the values listed above.

10. Accessories

10.1. Low viscosity adapters (LCP and LCP/B)

Low viscosity adapters (LCP y LCP/B) do not come with the standard delivery. Any of these two versions (with or without thermo station jacket) must be ordered as an additional accessory. Both LCP and LCP/B accessories are supplied complete with a spindle.

Low viscosity adapters allow more precise measurements than using the standard spindle. The viscometer can measure very low viscosity levels, from 1 cP (when using the L model). Thanks to its cylindrical geometry shape, it is possible to get Shear Rate determinations and Shear Stress.

Only a small quantity of a sample is needed (16-18 ml.)

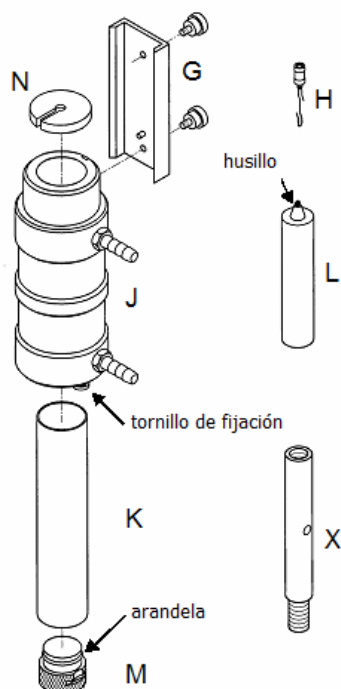

Fig. 8: LCP parts

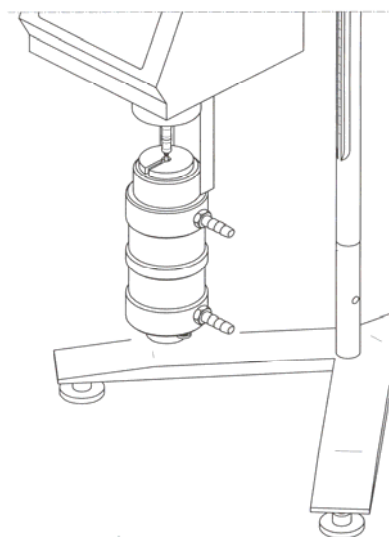

Fig.9: LCP adapter set in the viscometer

10.1.1 Mounting

The mounting process is the same for both types of low viscosity accessories (LCP and LCP/B). The sketches here only show the LCP.

- Unplug the viscometer.
- Attach the extension (X) between the base Y shaped (A) and the rib (C). Use a 19 mm adjustable spanner in order to fasten the nut (D).
- Assemble the viscometer again starting with the base. The extension (X) is necessary because of the length of the LCP adapter. Without this extension the assembly of this accessory would be difficult, especially the assembly of the spindle.

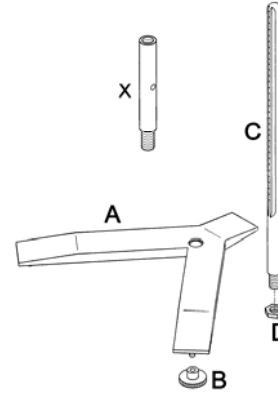

Fig. 10: Mounting the LCP adapter extension.

- Fasten the circulation jacket (J) to the connector (G) (figure 7).
- Fasten the connector (G) to the hole in the back of the viscometer's metallic base.
- Connect the hook (H) and the spindle (L)
- Insert the spindle (L) in the circulation jacket, and screw it with the viscometer axle by turning it clockwise.
- Close the sample (K) container with the stopper (M).
- Fill the sample container with a 20 ml syringe, or less, and fill the 16-18 ml sample container.
- Insert the container (K) to the lower part, in the circulation jacket (J).

Important:

Do this slowly since the spindle must be inserted correctly in the sample. When working with a more viscous sample, be careful to avoid pulling the spindle upwards. Hold the spindle connector.

- Insert the sample container (K) by turning it gently. Fit the spindle together with the lower stopper (M).
- Check the level of the sample. It should be approximately in the middle of the cone, which is connected to the spindle connector(H). Figure 10 shows more information about this
- Place the upper stopper (N) over the sample container.

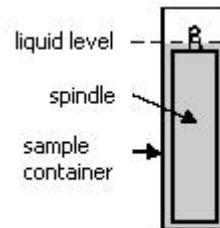

Fig. 11: Full LCP adapter.

NOTE:

Before starting with the measurements, make sure the viscometer is correctly balanced (check it with the bubble level). The spindle that should be selected is 'LCP/SP'.

10.1.2 Dismounting and clearing

- Place the viscometer upright. Remove the upper stopper (N).
- Unscrew the spindle of the viscometer axis and lower the spindle slowly in the sample container (K).
- Unscrew the bottom stopper (M) and remove the container(K) from below the thermo station jacket (J). Once the container is removed, remove the spindle carefully (L).
- Remove the container, wash it or use compressed air. Wash the circulation jacket too if necessary.

Important:

Do not use any cleaner or tool that can damage the metallic surface. Make sure you only use liquids that agree with the LCP adapter material!

Solvents that can be used: water, ethanol or high concentrations of alcohol. For other solvents, check the chemistry compatibility table.

10.1.3 Technical specification for LCP accessories

Measurements rank:

- Sample L: 0.9*) until 2 000 mPa.s or cP
- Sample R: 3.2**) until 21 333 mPa.s or cP

*) Limited by turbulences

**) For the measurements that represent 10 % of the base scale

Sample volume: 18.0 ml

Shear rate factor for the LCP spindle: 1.2236 x RPM (***)

***) Shear rate is calculated based on the features of Newtonian liquids.

Temperature rank of the circulation jacket & thermo station conditions:

- Temperature rank allowed: -10 a +100°C (14 a 212 °F)
- Use a thermo station wash with demineralised water or special refrigeration liquid. Change thermostat liquid regularly. Recommended flow: 15 l/min.

Materials:

- The metallic parts are made of stainless steel; the leads are made of black delrin plastic. The parts that come into contact with the sample (sample container and spindle) are made of AISI 316 and are suitable for the food industry.
- The lead inferior washer is made with black delrin. It is designed to withstand a maximum temperature of 100°C (212 °F)
- The circulation jacket is made of acetyl and Delrin.
- The O-ring on the plastic stopper (M) of the LCP Adapter is made of delrin. The softening point is 110 °C (230 °F).

10. 2. Small sample adapters APM and APM/B

NOTE:

Small sample adapters (APM and APM/B) do not belong to the standard delivery. Any of these two versions (with or without thermo station jacket) must be ordered as an additional accessory. APM and APM/B accessory are not supplied with a spindle. Special spindles (TL or TR) are used according to the viscometer sample (L, R or H).

Small sample adapters allow more precise measurements than the standard spindles. The measurement rank of a viscometer can get lower viscosity levels.

Thanks to its known cylindrical geometry shape, it is possible to get Shear Rate and Shear Stress determinations. Only a small quantity of the sample is needed.

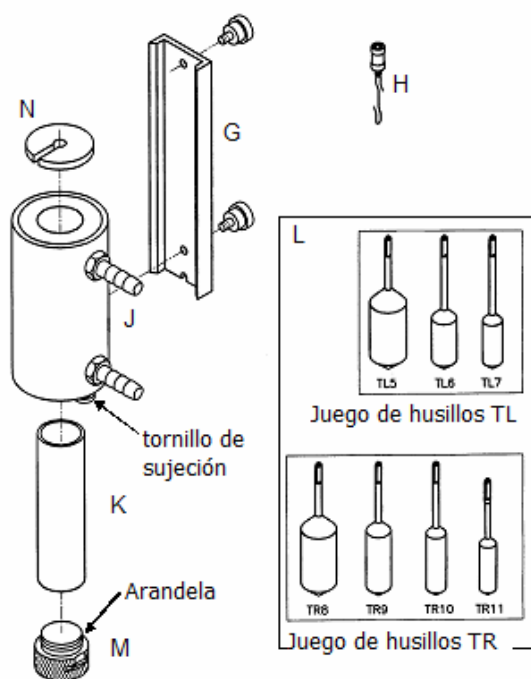

Fig. 12 APM accessory parts

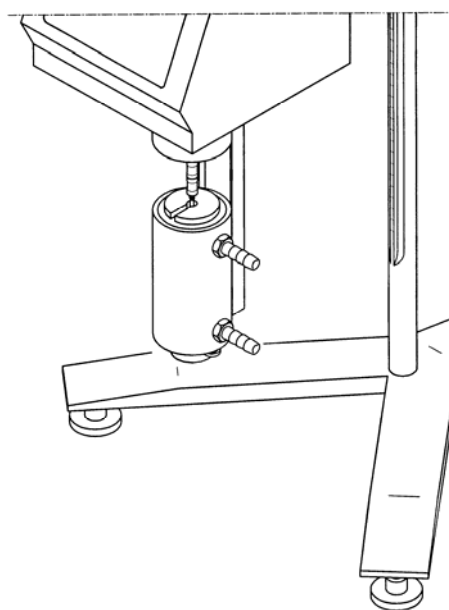

Fig. 13 Set APM

10. 2. 1 Assembly

NOTE:

The assembling process is the same for both types of low viscosity accessories (APM and APM/B). The sketches here only show the APM.

- The digital viscometer must be correctly fastened to the base.
- Fasten the circulation jacket (J) to the connector (G) (figure 11).
- Fasten the connector (G) to the hole at the back of the viscometer metallic vase.
- Connect the hook (H) and the spindle (L).
- Insert the spindle (L) in the circulation jacket, and screw it in to the viscometer axle by turning it clockwise.
- Close the sample (K) container with the bottom stopper (M).
- Fill the sample container with a 20 ml syringe, or less, and fill the container with the necessary sample quantity in proportion with the spindle (16 to 13 ml).
- Insert the sample container (K) by turning it gently, in the circulation jacket (J). Insert the screw (L) in the lower stopper (M), and screw it to the viscometer axle by turning it counter-clockwise.
- Make sure that the spindle is correctly submerged (the level in the sample must be above the upper part of the spindle). If necessary, add some more of the sample.
- Place the upper stopper (N) over the sample container.

NOTE:

Before starting with the measurements, make sure the viscometer is correctly balanced (check it with the bubble level).

10. 2. 2 Dismounting and Cleaning

- Place the viscometer upwards. Remove the superior lead (N).
- Unscrew the spindle of the viscometer axis and lower the spindle slowly into the sample container (K).
- Unscrew the bottom stopper (M) and place the container (K) below the thermo station jacket (J). Once the container is removed, remove the spindle carefully (L).
- Remove the container, wash it or use compressed air. Wash the circulation jacket too if necessary.

Important:

Do not use any cleaner or tool that can damage the metallic surface. Make sure you only use liquids that agree with the LCP adapter material!

Solvents that can be used: water, ethanol or high concentrations of alcohol. For other solvents, check the chemistry compatibility table.

10. 2. 3 Technical specifications of APM and APM/B

Measurement rank:

Sample L: 1.5*) until 200 000 mPa.s

Sample R: 25*) until 3 300 000 mPa.s

Sample H: 0.2*) until 26 660 Pa.s

*) Measurement represents a 10 % of the full scale.

Spindles features and APM filling:

- L Sample & TL spindles

Spindle	Shear rate [s ⁻¹] *)	Sample volume [ml]
TL5	1.32 x RPM	8.0
TL6	0.34 x RPM	10.0
TL7	0.28 x RPM	9.5

- R sample or H & TR spindles

Spindle	Shear rate [s ⁻¹] *)	Sample volume [ml]
TR8	0.93 x RPM	8.0
TR9	0.34 x RPM	10.5
TR10	0.28 x RPM	11.5
TR11	0.25 x RPM	13.0

*) Shear rate is calculated based on the features of Newtonian liquids.

Temperature rank of circulation jacket and thermo station conditions:

- Permitted temperature rank: -10 a +100°C (14 a 212 °F)
- Use a thermostatic bath with demineralised water or refrigeration special liquid. Change the liquid form the thermostat regularly. Recommended flow: 15 l/min.

Materials:

- The metallic parts are made of stainless steel, the leads are made of plastic in Delrin Negro. The parts in contact with the sample (sample container and spindle) are made of AISI 316 suitable for food industry.
- The lead inferior washer is made in black Delrin. It is designed to get a maximum temperature of 100°C (212 °F)
- The circulation jacket is made of acetyl and Delrin.
- The O-ring on the plastic stopper (M) of the LCP Adapter is made of Delrin. The softening point is 110 °C (230 °F).

10.3 HELDAL UNIT – Helicoidal Movement Unit

NOTE:

The Haldal adapter doesn't come with the standard delivery. It can be ordered as an accessory. The unit is supplied complete with T-shaped spindles, in this case.

The Haldal accessory is used with substances that do not flow by themselves (like ice or pastas). Its engine moves the viscometer slowly in a vertical movement and at the same time the spindle makes the rotation movement. This generates a helicoidal movement that makes that the T-shaped spindle is always in contact with the sample.

The measurements obtained with Haldal do not measure absolute viscosity! They are only comparative measurements with the same geometry as T-shaped spindles.

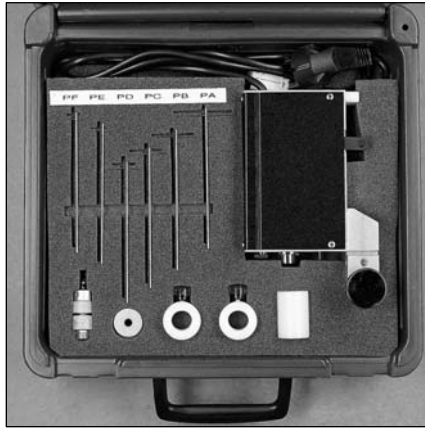

Fig. 13 Heldal Unit in its case

10. 3. 1 Heldal unit mounting

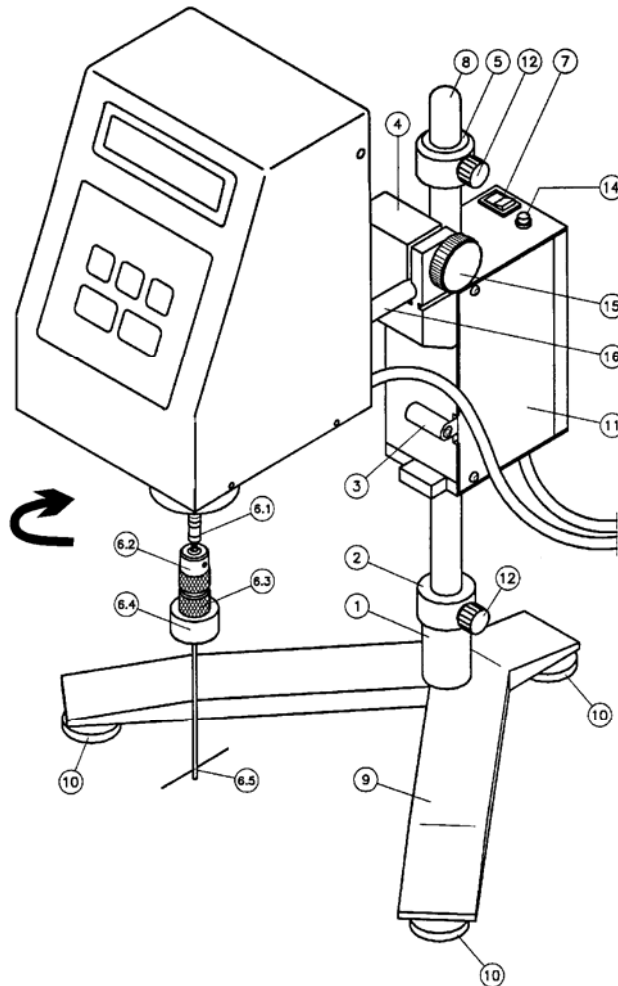

Fig. 14 Heldal unit set in the viscometer

1. Rib joint	9. Base
2. Lower stop ring	10. Levelling knobs
3. Displacement command	11. Heldal engine unit
4. Viscometer fastening bolt	12. Knobbed fastening rib
5. Upper stopper ring	14. Functioning pilot
6. Heldal fastening group	15. Nut bolt
7. ON/OFF switch	16. Viscometer fastening rib
8. Fastener	

6.1 Spindle connector
6.2 Upper spindle receptor
6.3 Lower spindle receptor
6.4 Counterweight, spindle connector
6.5 Spindle

- Place the fastener (8) facing the short end of the Y-shaped base (9).
- Place the safety shell (1) over the fastening rib (8) on the base of the viscometer (9).
- Place the lower ring in the fastener (8) as explained in the sketch, and fasten it with the knobbed fastening rib (12).

Important:

Do not fasten the stop rings to the fastening ribs (12) too tightly. They are plastic pieces and they can be damaged. Both stopper rings (upper and lower) look exactly the same, and can be changed.

- Place the Heldal engine (11) in the fastener(8) while pressing the displacement command (3).
- Connect the upper stop ring to the fastener (8) and fasten it with the fastening rib (12).
- Insert the viscometer by placing the fastening rib (16) in the Heldel bolt (4), and fasten it with the nut bolt (15).
- Balance the viscometer – Heldal set with the balancing knobs (10).
- Fasten the T-shaped spindle (PA to PF samples) to the viscometer. In order to choose the right one, look at the selection tables (T.3).
 - Screw the counterweight (6.4) in the lower part of the spindle receptor (6.3).
 - Insert the spindle receptor (6.5) between both upper and lower parts of the spindle receptor (6.2 and 6.3). Do not separate these two parts.
 - Fasten the spindle and screw in the lower part of the receptor (6.3) until it is completely fastened.

Important:

Do not fasten the spindle tighter than necessary. There should always be a small hole between both parts of the receptor.

- Fasten the spindle receptor and the spindle to the axis of the viscometer, by connecting the thread.
- Place the sample container under the viscometer and insert the spindle into the sample fluid by pressing the displacement button (3).
- The stopper rings limit the vertical movement of the spindle. Therefore, these two rings must be fastened correctly and in their correct positions.

Important:

Placement of stopper rings as explained here:

- Upper ring: the spindle should be kept in the same fluid
- Lower stopper ring: The spindle must not touch the edge of the container. If so, the viscometer's axle can be damaged and the results can be wrong.
- Once the rings are fastened, connect the viscometer and the Heldal to the power point. Switch the viscometer on and insert the speed and the spindle, as always.
- Set the Heldal unit on with the ON/OFF switch (7). Check if the pilot is on. If not, check the main connection.

OPERATION:

The Heldal unit (which moves helicoidally) is moved up and down between the two stopper rings.

When the engine touches one of them, the unit changes direction.

The Heldal unit will keep moving, until turned with the ON/OFF switch (7).

11. Model/Spindle correspondence tables

Standard Spindles + R1 (Table 1):

Viscometer model	Spindle
ALPHA L	L1
	L2
	L3
	L4
ALPHA R	R1
	R2
	R3
	R4
	R5
	R6
	R7
ALPHA H	R1
	R2
	R3
	R4
	R5
	R6
	R7

SPECIAL SPINDLES (Table 2):

Viscometer model	Spindle
ALPHA L	TL5
	TL6
	TL7
ALPHA R	TR8
	TR9
	TR10
	TR11
ALPHA H	TR8
	TR9
	TR10
	TR11

SPECIAL HELDAL SPINDLES (Table 3):

Viscometer model	Spindle
ALPHA L	PA
	PB
	PC
	PD
	PE
	PF
ALPHA R	PA
	PB
	PC
	PD
	PE
	PF
ALPHA H	PA
	PB
	PC
	PD
	PE
	PF

SPECIAL SPINDLES (Table 4):

Viscometer model	Spindle
ALPHA L	LCP/SP
ALPHA R	LCP/SP

12. Model/Spindle/Oil calibration tables

MODEL L (Table 5):

Spindle	Standard Oil
L1	RT50
L2	RT500
L3	RT1000
L4	RT5000
TL5	RT50
TL6	RT500
TL7	RT500
LCP	RT5

MODEL R (Table 6):

Spindle	Standard Oil
R1	RT50
R2	RT500
R3	RT500
R4	RT1000
R5	RT5000
R6	RT5000
R7	RT30000
TR8	RT500
TR9	RT5000
TR10	RT5000
TR11	RT5000
LCP	RT50

MODEL H (Table 7):

Spindle	Standard Oil
R1	
R2	
R3	
R4	
R5	
R6	
R7	
TR8	
TR9	
TR10	
TR11	

Table 8. ALPHA L standard spindle selection

Maximum guideline values in cP (mPa·s)

RPM / SP	L1	L2	L3	L4
0,3	20K	100K	400K	2000K
0,5	12K	60K	240K	1200K
0,6	10K	50K	200K	1000K
1	6K	30K	120K	600K
1,5	4K	20K	80K	400K
2	3K	15K	60K	300K
2,5	2,4K	12K	48K	240K
3	2K	10K	40K	200K
4	1,5K	7,5K	30K	150K
5	1,2K	6K	24K	120K
6	1K	5K	20K	100K
10	600	3K	12K	60K
12	500	2,5K	10K	50K
20	300	1,5K	6K	30K
30	200	1K	4K	20K
50	120	600	2,4K	12K
60	100	500	2K	10K
100	60	300	1,2K	6K

ATTENTION:

K Indicates miles.

Example: 7,8K = 7.800

M Indicates Millions

Example: 1,56M = 1.560.000

NOTE:

It is not recommended to work with viscosity values of less than 15% of the lower part of the selected scale.

Table 9. ALPHA L Special spindle selection

Maximum guideline values in cP (mPa·s)

RPM / SP	TL5	TL6	TL7
0,3	10K	100K	200K
0,5	6K	60K	120K
0,6	5K	50K	100K
1	3K	30K	60K
1,5	2K	20K	40K
2	1,5K	15K	30K
2,5	1,2K	12K	24K
3	1K	10K	20K
4	750	7,5K	15K
5	600	6K	12K
6	500	5K	10K
10	300	3K	6K
12	250	2,5K	5K
20	150	1,5K	3K
30	100	1K	2K
50	60	600	1,2K
60	50	500	1K
100	30	300	600

ATTENTION:

K Indicates miles.

M Indicates millions

Example: 7,8K = 7.800

Example: 1,56M = 1.560.000

NOTE:

It is not recommended to work with viscosity values of less than 15% of the lower part of the selected scale.

Table 10. LCP Adaptor with ALPHA L

Maximum guideline values in cP (mPa·s)

RPM	LCP
0,3	2.000,00
0,5	1.200,00
0,6	1.000,00
1	600,00
1,5	400,00
2	300,00
2,5	240,00
3	200,00
4	150,00
5	120,00
6	100,00
10	60,00
12	50,00
20	30,00
30	20,00
50	12,00
60	10,00
100	6,00

NOTE:

It is not recommended to work with viscosity values of less than 15% of the lower part of the selected scale.

Sample Volume = 18 ml.
Shear Rate = 1,2236·rpm

Table 11. ALPHA R Standard spindle selection

Maximum guideline values in cP (mPa·s)

RPM / SP	R1	R2	R3	R4	R5	R6	R7
0,3	33,3K	133,3K	333,3K	666,6K	1,3M	3,33M	13,3M
0,5	20K	80K	200K	400K	800K	2M	8M
0,6	16,6K	66,6K	166,6K	333,3K	666,6K	1,6M	6,6M
1	10K	40K	100K	200K	400K	1M	4M
1,5	6,6K	26,6K	66,6K	133,3K	66,6K	666,6K	2,6M
2	5K	20K	50K	100K	200K	500K	2M
2,5	4K	16K	40K	80K	160K	400K	1,6M
3	3,3K	13,3K	33,3K	66,6K	133,3K	333,3K	1,3M
4	2,5K	10K	25K	50K	100K	250K	1M
5	2K	8K	20K	40K	80K	200K	800K
6	1,6K	6,6K	16,6K	33,3K	66,6K	166,6K	666,6K
10	1K	4K	10K	20K	40K	100K	400K
12	833	3,3K	8,3K	16,6K	33,3K	83,3K	333,3K
20	500	2K	5K	10K	20K	50K	200K
30	333	1,3K	3,3K	6,6K	13,3K	33,3K	133,3K
50	200	800	2K	4K	8K	20K	80K
60	166	660	1,6K	3,3K	6,6K	16,6K	66,6K
100	100	400	1K	2K	4K	10K	40K

ATTENTION:

K Indicates miles.

Example: 7,8K = 7.800

M Indicates millions

Example: 1,56M = 1.560.000

NOTE:

It is not recommended to work with viscosity values of less than 15% of the lower part of the selected scale.

TABLE 12. ALPHA R special spindle selection

Maximum guideline values in cP (mPa·s)

RPM / SP	TR8	TR9	TR10	TR11
0,3	166,6K	833,3K	1,6M	3,3M
0,5	100K	500K	1M	2M
0,6	83,3K	416,6K	833,3K	1,6M
1	50K	250K	500K	1M
1,5	33,3K	166,6K	333,3K	666,6K
2	25K	125K	250K	500K
2,5	20K	100K	200K	400K
3	16,6K	83,3K	166,6K	333,3K
4	12,5K	62,5K	125K	250K
5	10K	50K	100K	200K
6	8,3K	41,6K	83,3K	166,6K
10	5K	25K	50K	100K
12	4,16K	20,83K	41,6K	83,3K
20	2,5K	12,5K	25K	50K
30	1,6K	8,3K	16,6K	33,3K
50	1K	5K	10K	20K
60	833,3	4,16K	8,3K	16,6K
100	500	2,5K	5K	10K

ATTENTION:

K Indicates miles.

Example: 7,8K = 7.800

M Indicates millions

Example: 1,56M = 1.560.000

NOTE:

It is not recommended to work with viscosity values of less than 15% of the lower part of the selected scale.

Table 13. LCP Adaptor with ALPHA R

Maximum guideline values in cP (mPa·s)

RPM	LCP
0,3	21.333,00
0,5	12.800,00
0,6	10.666,00
1	6.400,00
1,5	4.266,00
2	3.200,00
2,5	2.560,00
3	2.133,00
4	1.600,00
5	1.280,00
6	1.066,00
10	640,00
12	533,00
20	320,00
30	213,00
50	128,00
60	106,00
100	64,00

NOTE:

It is not recommended to work with viscosity values of less than 15% of the lower part of the selected scale

Volume of the sample = 18 ml.

Shear Rate = 1,2236·rpm

Table 14. ALPHA H standard spindle selection

Maximum value guidelines, in units of poise

RPM/SP	R1	R2	R3	R4	R5	R6	R7
0,3	2,6K	10,6K	26,6K	53,3K	106,6K	266,6K	1,06M
0,5	1,6K	6,4K	16K	32K	64K	160K	640K
0,6	1,3K	5,3K	13,3K	26,6K	53,3K	133,3K	533,3K
1	800	3,2K	8K	16K	32K	80K	320K
1,5	533,3	2133	5,3K	10,6K	21,3K	53,3K	213,3K
2	400	1,6K	4K	8K	16K	40K	160K
2,5	320	1,28K	3,2K	6,4K	12,8K	32K	128K
3	266,6	1066	2,6K	5,3K	10,6K	26,6K	106,6K
4	200	800	2K	4K	8K	20K	80K
5	160	640	1,6K	3,2K	6,4K	16K	64K
6	133,3	533,3	1,3K	2,6K	5,3K	13,3K	53,3K
10	80	320	800	1,6K	3,2K	8K	32K
12	66,6	266,6	666	1,3K	2,6K	6,6K	26,6K
20	40	160	400	800	1,6K	4K	16K
30	26,6	106,6	266	533	1066	2,6K	10,6K
50	16	64	160	320	640	1,6K	6,4K
60	13,3	53,3	133,3	266,6	533	1,3K	5,3K
100	8	32	80	160	320	800	3,2K

ATTENTION:

K Indicates miles.

Example: 7,8K = 7.800

M Indicates millions

Example: 1,56M = 1.560.000

NOTE:

It is not recommended to work with viscosity values of less than 15% of the lower part of the selected scale.

Table 15. ALPHA H special spindle selection

Maximum value guidelines, in units of poise

RPM / SP	TR8	TR9	TR10	TR11
0,3	13,6K	66,6K	133,3K	266,6K
0,5	8K	40K	80K	160k
0,6	6,6K	33,3K	66,6K	133,3K
1	4K	20K	40K	80K
1,5	2,6K	13,3K	26,6K	53,3K
2	2K	10K	20K	40K
2,5	1,6K	8K	16K	32K
3	1,3K	6,6K	13,3K	26,6K
4	1K	5K	10K	20K
5	800	4K	8K	16K
6	666	3,30K	6,6K	13,3K
10	400	2K	4K	8K
12	333	1,6	3,3K	6,6K
20	200	1K	2K	4K
30	133	666	1,3K	2,6K
50	80	400	800	1,6K
60	66	333	666	1,3K
100	40	200	400	800

ATTENTION:

K Indicates miles.

Example: 7,8K = 7.800

M Indicates millions

Example: 1,56M = 1.560.000

NOTE:

It is not recommended to work with viscosity values of less than 15% of the lower part of the selected scale.

Table 16. HELDAL's special spindle selection for ALPHA L

Maximum guideline values in cP (mPa·s)

RPM/SP	PA	PB	PC	PD	PE	PF
0,3	62,4K	124,8K	312K	624K	1,56M	3,12M
0,5	37,44K	74,88K	187,2K	374,4K	936K	1,872M
0,6	31,2K	62,4K	156K	312K	780K	1M
1	18,72K	37,44K	93,6K	187,2K	468K	936K
1,5	12,48K	24,96K	62,4K	124,8K	312K	624K
2	9,36K	18,72K	46,8K	93,6K	234K	468K
2,5	7,488K	14,976K	37,44K	74,88K	187,2K	374,4K
3	6,24K	12,48K	31,2K	62,4K	156K	312K
4	4,68K	9,36K	23,4K	46,8K	117K	234K
5	3,744K	7,488K	18,72K	37,44K	93,6K	187,2K
6	3,120K	6,24K	15,6K	31,2K	78K	156K
10	1,872K	3,744K	9,36K	18,72K	46,8K	93,6K
12	1,560K	3,12K	7,8K	15,6K	39K	78K

ATTENTION:

K Indicates miles.

Example: 7,8K = 7.800

M Indicates millions

Example: 1,56M = 1.560.000

NOTE:

It is not recommended to work with viscosity values of less than 15% of the lower part of the selected scale.

Table 17. HELDAL's special spindle selection for ALPHA R

Maximum guideline values in cP (mPa·s)

RPM/SP	PA	PB	PC	PD	PE	PF
0,3	666,6K	1,3M	3,3M	6,6M	16,6M	33,3M
0,5	400K	800K	2M	4M	10M	20M
0,6	333,3K	666,6K	1,6M	3,3M	8,3M	16,6M
1	200K	400K	1M	2M	5M	10M
1,5	133,3K	266,6K	666,6K	1,3M	3,3M	6,6M
2	100K	200K	500K	1M	2,5M	5M
2,5	80K	160K	400K	800K	2M	4M
3	66,6K	133,3K	333,3K	666,6K	1,6M	3,3M
4	50K	100K	250K	500K	1,25M	2,5M
5	40K	80K	200K	400K	1M	2M
6	33,3K	66,6K	166,6K	333,3K	833,3K	1,6M
10	20K	40K	100K	200K	500K	1M
12	16,6K	33,3K	83,3K	166,6K	416,6K	833,2K

ATTENTION:

K Indicates miles.

Example: 7,8K = 7.800

M Indicates millions

Example: 1,56M = 1.560.000

NOTE:

It is not recommended to work with viscosity values of less than 15% of the lower part of the selected scale.

Table 18. HELDAL's special spindle selection for ALPHA H

Maximum guideline values in poise

RPM/SP	PA	PB	PC	PD	PE	PF
0,3	53,3K	106K	266,6K	533,3K	1,3M	2,6M
0,5	32K	64K	160K	320K	800K	1,6M
0,6	26,6K	53,3K	133,3K	266,6K	666,6K	1,3M
1	16K	32K	80K	160K	400K	800K
1,5	10,6K	21,3K	53,3K	106K	266,6K	533,3K
2	8K	16K	40K	80K	200K	400K
2,5	6,4K	12,8K	32K	64K	160K	380K
3	5,3K	10,6K	26,6K	53,3K	133,3K	266,6K
4	4K	8K	20K	40K	100K	200K
5	3,2K	6,4K	16K	32K	80K	160K
6	2,6K	5,3K	13,3K	26,6K	66,6K	133,3K
10	1,6K	3,2K	8K	16K	40K	80K
12	1,3K	2,6K	6,6K	13,3K	33,3K	66,6K

ATTENTION:

K Indicates miles.

Example: 7,8K = 7.800

M Indicates millions

Example: 1,56M = 1.560.000

NOTE:

It is not recommended to work with viscosity values of less than 15% of the lower part of the selected scale.