

PH800

Benchtop pH Meter

Instruction Manual

PH800 Lab pH Meter



EC800 Lab Conductivity Meter



PC800 Lab pH/Conductivity Meter





APER A INSTRUMENTS (Europe) GmbH

www.aperainst.de

Table of Contents

1	Brief Introduction	3
1.1	Measuring Parameters.....	3
1.2	Features and Functions.....	3
1.3	Features in pH Measurement (Applicable Models: PH800, PC800).....	4
1.4	Features in Conductivity Measurement (Applicable Models: EC800, PC800)	4
2	What's in the Box?	4
3	Technical Specifications	5
4	Instrument Description	6
5	pH Measurement	9
5.1	Preparation	9
5.2	pH Electrode Information	10
5.3	Information regarding pH Calibration	11
5.4	pH Calibration (Take 3-point calibration as an example)	13
5.5	Sample Measurement	14
5.6	Maintenance of the pH Electrode.....	15
6	mV Measurement	16
6.1	mV Measurement.....	16
6.2	Notes on ORP measurement	17
7	Conductivity Measurement	17
7.1	Set up flexible Electrode Holder (refer to 4.1)	17
7.2	Information regarding the Conductivity Electrode	17
7.3	Information regarding Conductivity Calibration	18
7.4	Conductivity Calibration (take 1413 $\mu\text{S}/\text{cm}^2$ as an example)	20
7.5	TDS, Salinity, Resistivity & Conductivity	20
7.6	Sample Test.....	21
7.7	Maintenance of the Conductivity Electrode.....	22
8	Parameter Setting	22
9	USB Data Communication	27
10	Recommended pH Electrodes for Specific Applications	29
11	Warranty	29
12	APPENDIX 1: TABLE OF PARAMETER SETTING AND FACTORY DEFAULT SETTING	30
13	APPENDIX 2: ICONS AND ABBREVIATION	31
14	APPENDIX 3: TABLE OF SELF-DIAGNOSIS SYMBOL	32

Special Notes

- Do NOT pull out the power plug until the meter is turned off.
- Don't pull out USB plug or press  button to turn off the meter directly when the meter is connecting with PC. Please press "Exit" button first (in the PC interface) to quit PC Link Software, then press  button to turn off the meter, and pull out USB plug after that.
- There is a CR2032 3V lithium battery in the meter's circuit board, see the picture on the right. It's power source for meter inner clock. When the voltage is lower than 2.6V after long time use, a blue screen with on display values and icons may appear when turn on the meter. At that moment, please open the meter and replace a new CR2032 3V lithium battery.



1 BRIEF INTRODUCTION

Thank you for purchasing PH800 Benchtop pH Meter. Before using the product, please read this manual carefully to help you properly use and maintain the product.

1.1 Measuring Parameters

Measuring Parameters	PH800	EC800	PC800
pH/mV	√		√
Conductivity/TDS//Salinity/Resistivity		√	√
Temperature	√	√	√

1.2 Features and Functions

- The built-in microprocessor chip enables advanced functions such as auto calibration, auto temperature compensation, auto electrode recognition, parameter setting, self-diagnosis, calibration reminder, calibration time check, auto power-off, low-battery reminder, etc.
- GLP data management, real-time clock display. Manual or Auto timing data storage. USB data communication.
- The meter adopts advanced digital processing technology, intelligently improves the response time and accuracy of the measurements. Stable reading and auto lock display mode are

available for choice.

- Meets IP54 Waterproof and dustproof rating, connectors of the meter protected by rubber cap, ensuring quality, reliability and service life especially in tough environments.

1.3 Features in pH Measurement (Applicable Models: PH800, PC800)

- 1 to 3 points auto calibration with calibration guide and auto-check function .
- Automatic recognition of up to 8 types of calibration solutions. Two series of standard solutions for choice: USA and NIST.
- Automatic display of electrode slope.

1.4 Features in Conductivity Measurement (Applicable Models: EC800, PC800)

- 1 to 4 points auto calibration with calibration guide and auto-check function.
- Single-tap switch among conductivity, TDS, salinity, and resistivity

2 WHAT'S IN THE BOX?

	Content	Quantity	PH800	EC800	PC800
1	PH800 Lab pH Meter	1	√		
2	EC800 Lab Conductivity Meter	1		√	
3	PC800 Lab pH/Conductivity Meter	1			√
4	201T-F 3-in-1 Combination pH Electrode ATC	1	√		√
5	2301T-F Conductivity Electrode ATC (ATC , k=1.0)	1		√	√
6	pH Standard Buffer (4.00 pH,7.00 pH,10.01pH/50mL)	1 for each	√		√
7	Conductivity Standard Solution (84μS,1413μS,12.88mS/50mL)	1 for each		√	√
8	9V Power Adapter	1	√	√	√
9	Flexible Electrode Holder	1	√	√	√
10	PC-Link Software Disk	1	√	√	√
11	USB Cable	1	√	√	√
12	Instruction Manual	1	√	√	√
13	Quick Manual	1	√	√	√

3 TECHNICAL SPECIFICATIONS

	Technical Parameters		Applicable Models
pH	Measuring Range	(-2.00 ~ 19.99) pH	PH800 PC800
	Resolution	0.1/0.01 pH	
	Accuracy	±0.01 pH ±1 digit	
	Temperature Compensation Range	(0 ~ 100°C) Automatic or Manual	
mV	Measuring Range	±1999mV	
	Resolution	1mV	
	Accuracy	±0.1% FS ±1 digit	
Cond.	Measuring Range	Conductivity: (0~200) mS/cm , including 5 ranges: (0.00~19.99)μS/cm, (20.0~199.9)μS/cm, (200~1999)μS/cm, (2.00~19.99)mS/cm, (20.0~199.9)mS/cm.	EC800 PC800
		TDS : (0 ~ 100)g/L , including 5 ranges: (0.00~9.99)mg/L, (10.0~99.9)mg/L (100~999)mg/L, (1.00~9.99)g/L (10.0~99.9)g/L	
		Salinity: (0~100) ppt, including 2 ranges: (0 ~ 9.99) ppt, (10.0 ~99.9) ppt,	
		Resistivity: (0~100) MΩ·cm, including 6 ranges: (0 .0~ 99.9)Ω·cm, (100~ 999)Ω·cm, (1.00~ 9.99)KΩ·cm, (10.0~ 99.9)KΩ·cm, (100~ 999)KΩ·cm, (1.0~ 99.9)MΩ·cm,	
	Resolution	Conductivity : 0.01/0.1/1μS/cm , 0.01/0.1 mS/cm TDS : 0.01/0.1/1mg/L 0.01/0.1g/L Salinity : 0.01/0.1/1 ppt, 0.01/0.1 ppt. Resistivity : 0.1/1Ω·cm, 0.01/0.1/1 KΩ·cm, 0.1 MΩ·cm.	
	Accuracy	±1.0% FS ±1 digit	
	Temperature Compensation Range	(0 ~ 50°C) Automatic or Manual	
	Electrode Constant	0.1 / 1 / 10 cm ⁻¹	
Temp.	Measuring Range	0 to 100°C	PH800 EC800 PC800
	Resolution	0.1°C	
	Accuracy	±0.5°C ±1 digit	
Other	Data Storage	PH800/EC800 : 500 Groups ; PC800 : 1000 Groups	
	Storage Content	Numberings, Date, Time, Measurements, Unit, Temperature	
	Data Output	USB	
	IP Rating	IP54 Waterproof and Dustproof	
	Calibration	pH : 1~3 points , Conductivity : 1~4 points	

4 INSTRUMENT DESCRIPTION

4.1 LCD Display

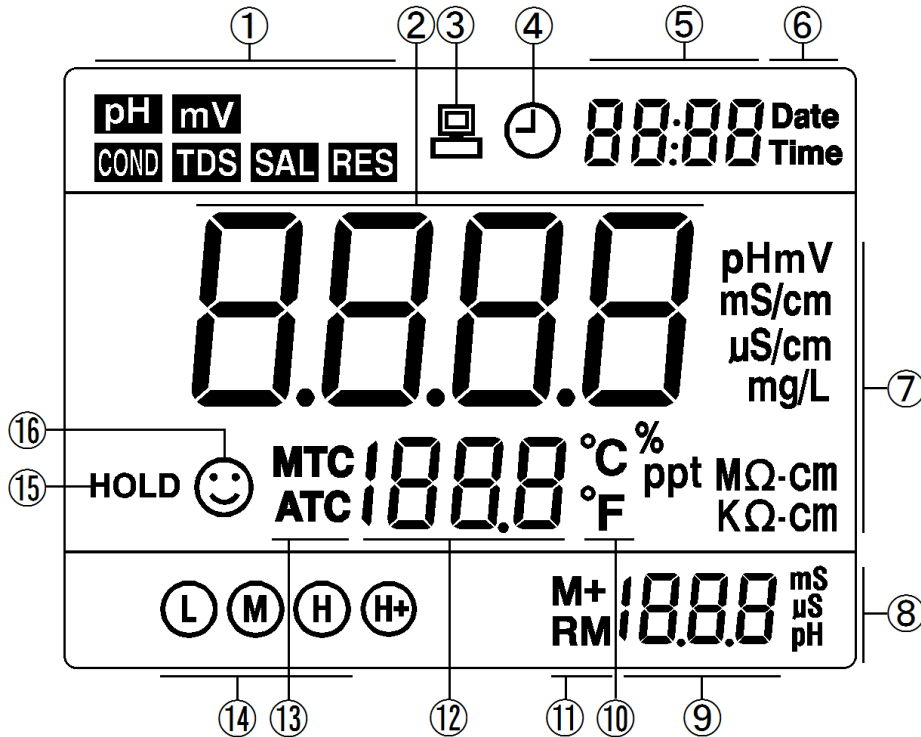

Figure-1

- ① — Measuring parameters
- ② — Measuring value
- ③ — USB data communication. The meter is connected to your PC when this icon is displayed.
- ④ — Timing storage
- ⑤ — Date, time, and reminder icons
- ⑥ — “Date” and “Time”
- ⑦ — Measuring unit
- ⑧ — Measuring unit in calibration
- ⑨ — Calibration value, numberings of data storage, and reminder icons
- ⑩ — Temperature unit
- ⑪ — Data storage and display icon
M+— Data storage; RM— Recall saved data
- ⑫ — Temperature and reminder icons
- ⑬ — ATC—Auto Temperature Compensation; MTC— Manual Temperature Compensation
- ⑭ — Completed calibration icons
- ⑮ — Auto-Lock reading mode
- ⑯ — Stable reading icon

4.2 Keypad

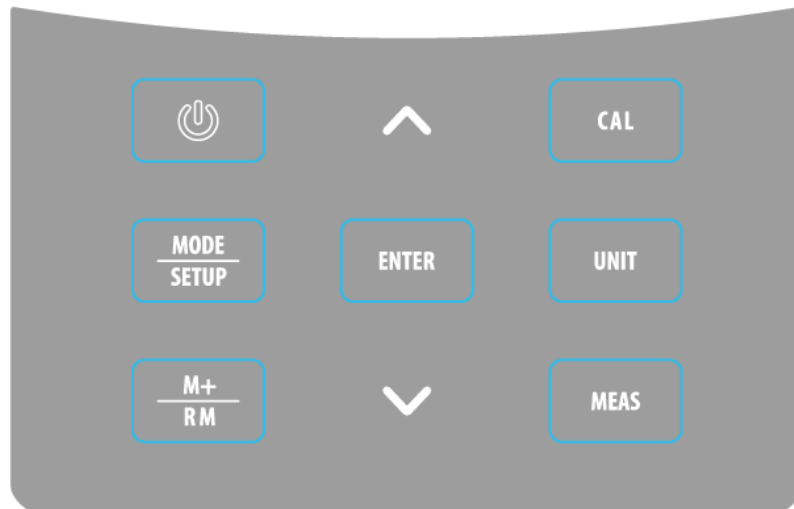

Figure-2

Short Press — <1.5 s ; Long Press — >1.5 s

Table-1 Keypad Operation and Functions

Keypad	Operation	Functions
	Short Press	<ul style="list-style-type: none"> ● Power on/off
	Short Press	Choose measuring mode: <ul style="list-style-type: none"> ● pH Meter : pH → mV ● pH/Conductivity Meter : pH → mV → COND
	Long Press	<ul style="list-style-type: none"> ● Enter parameter setting
	Short Press	<ul style="list-style-type: none"> ● Enter calibration mode
	Short Press	<ul style="list-style-type: none"> ● In pH mode: choose resolution: 0.1 pH→0.01pH ● In conductivity mode, choose measuring mode: COND → TDS → SAL → RES
	Short Press	<ul style="list-style-type: none"> ● In calibration mode: press to calibrate ● In parameter setting mode: press to confirm choice
	Short Press	<ul style="list-style-type: none"> ● Cancel any operation, the meter goes back to measurement mode
	Short Press	<ul style="list-style-type: none"> ● Save measuring data
	Long Press	<ul style="list-style-type: none"> ● Recall saved measuring data
 	Short Press or Long Press	<ul style="list-style-type: none"> ● In manual temperature compensation (MTC) mode: Short press to adjust temperature, long press to adjust swiftly ● In parameter setting mode: press to change the numbering of parameters in main menu and sub-menu. ● In sub-menu, press to change parameters and settings. ● In recall mode (RM), short press to change numberings, long press to change swiftly.

4.3 Connectors

Table-2 Connectors of Different Models

Connectors	Model
	PH800 pH Meter
	EC800 Conductivity Meter
	PC800 pH/Conductivity Meter

Table-3 Connector Name and Type

Icon	Connector Name	Connector Type
REF	Reference Electrode Plug	Φ2 Banana Plug
pH/mV	pH Electrode and ORP Electrode Plug	BNC Connector
TEMP	Temperature Plug (sharing for pH and conductivity)	RCA Connector
COND	Conductivity Plug	BNC Connector
USB	USB Communication Plug	Standard Four Core Connector
DC9V	DC9V Power Plug	Φ2.5 Power Plug

special notes: don't pull out the power plug when the meter is working. It should be pulled out only after the meter is turned off.

4.4 Display Mode

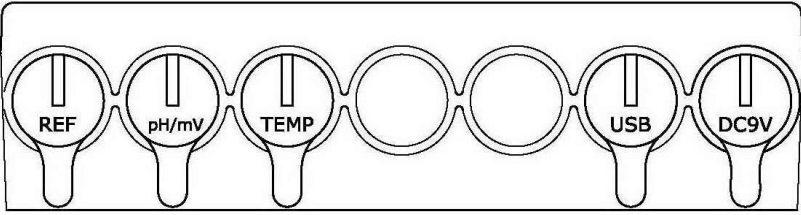
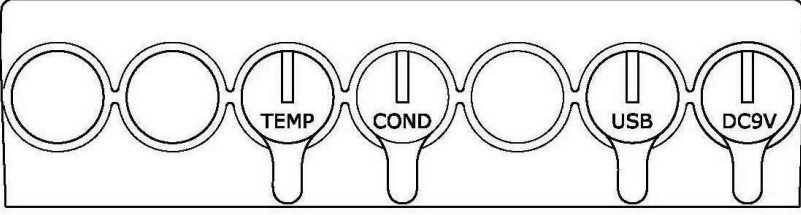
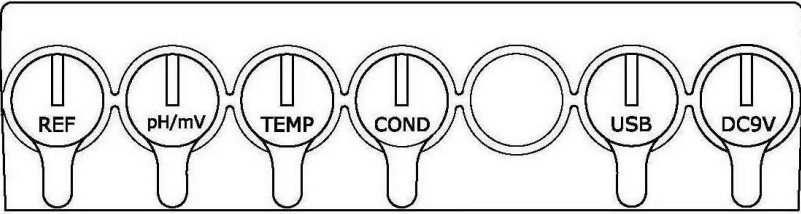
4.4.1 Stable Reading Display Mode

When the measuring value is stable, the screen displays ☺ as shown in figure-3. If ☺ does not appear or is flashing, that means the measuring value has not been stable. Users should wait for the smiley face to appear and stay before record the readings or conduct calibrations.

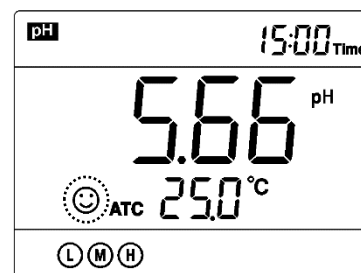

Figure-3

4.4.2 Auto-Lock Display Mode

In parameter setting P5.4, select "On" to turn on the auto-lock display mode, in which the reading will be automatically locked after ☺ icon has been stably displaying for 10 seconds, and the HOLD icon will come up as shown in figure-4. At this time short press **MEAS** to cancel the hold.

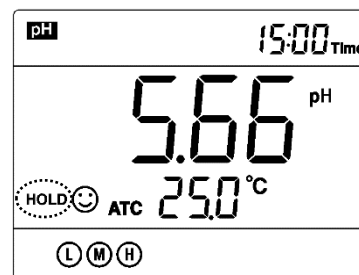

Figure-4

4.5 Data Storage, Recall, and Deletion

4.5.1 Manual Data Storage

When reading is stable, short press **M+/RM**, the screen will display M+ Icon along with the storage numbering, and the data will be saved, as shown in figure-5. For the storage capacity for each model, please refer to Section 2.

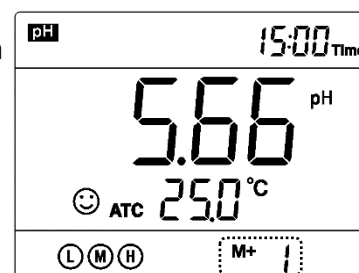

Figure-5

4.5.2 Automatic Timing Data Storage

In parameter setting P5.1, set up the time for timing measurements (e.g. 3 minutes). ⌚ be displayed, meaning the meter is ready to enter the auto timing storage mode. Short press **M+/RM**, the ⌚ icon will start flashing, and the 1st group of data will be stored. 3 minutes later, the 2nd one will be stored. Figure-6 shows that 8 groups of data have been automatically stored. Short press **M+/RM** again, the ⌚ icon will stop flashing. The meter stops the auto timing storage. When in auto timing storage, manual storage is disabled. In parameter setting P5.1, set the time to 0 to exit auto timing storage.

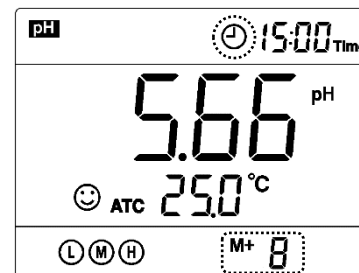

Figure-6

4.5.3 Recall the Stored Data

In measurement mode, long press **M+/RM** (>1.5 s), the meter will recall the Measured value that was lastly saved, as shown in figure-7, displaying RM Icon and the numbering. Press **△** or **▽** to recall other stored data. Long press **△** or **▽** to change numberings swiftly.

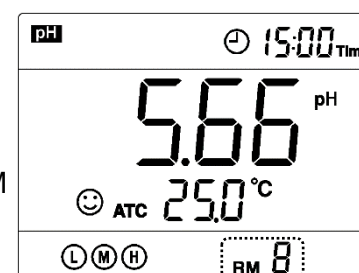

Figure-7

4.5.4 Clear Stored Data

In parameter P5.3, select Yes to clear all the stored data. For details, please refer to Section 7.5

5 pH Measurement

5.1 Preparation

5.1.1 Set up the Flexible Electrode Holder

The flexible electrode holder is composed of a base and an electrode holder. Place the electrode

holder right above the metal stick on the base through the hole underneath; push down; and adjust the nut on electrode holder to finish installation.

5.1.2 Connect the power adapter

Plug the power adapter tightly into the DC9V socket. The power's voltage should meet the requirements listed on the power adapter.

5.1.3 Things needed in addition to what's included in the box

A clean cup, distilled or deionized water (8-16oz), and tissue papers for rinsing and drying the probe.

5.2 pH Electrode Information

5.2.1 pH Electrode

The meter comes with the 201T-F 3-in-1 combination electrode with a built-in temperature sensor, which enables the automatic temperature compensation. This electrode is only suitable for regular water solutions' pH testing. Please refer to Section 10 for ideal pH electrodes to use for other specific applications. The electrode's housing adopts polycarbonate materials, which is resistant to shocks and corrosion. A 3M KCL storage bottle comes with the electrode, which is for storing the electrode when not in use to keep the sensitivity of the probe.

5.2.2 Technical Specifications of the 201T-F pH Electrode

Measurement Range: 0 - 14 pH, 0 - 80°C (32 – 176°F)

Junction: Single Ceramic

Reference Electrode: Ag/AgCl

Connector: BNC/RCA

Size: \varnothing 12*160 mm

Temperature unit: 30K Ω Thermistor

5.2.3 Electrode Connectors

The pH electrode has two connectors: the BNC connector connects the pH probe; the RCA connector connects the temperature sensor. Plug these two connectors into 'pH/mV' and "TEMP" sockets. Please note not to pull the cables in case of poor contact. Please keep the connectors clean and dry. Refer to section 4.7 regarding how to properly maintain the pH electrode.

5.2.4 How to Measure with the Electrode

Screw off the KCL storage bottle, and put it aside (do not dump or spill the KCL solution). Prepare a cup of distilled or deionized water, and rinse the electrode in it for a few seconds. Gently shake the probe to remove excess water, and dry it with clean tissue paper (DO NOT rub or wipe the probe, just use paper to dap off excess water). Gently stir the electrode for a few seconds after it's dipped into the test solution and then let it stand still. Wait for the stable measurement (a smiley face appears and stays) and then record the readings. When test is finished, place the electrode in the storage

bottle and tighten the cap in order to keep the sensitivity of the pH sensor.

Notes:

- 1) This default 201T-F electrode **will NOT** give accurate and stable pH readings when testing purified water such as distilled or deionized water. To measure distilled or deionized water's pH, users need to use a specialized pH electrode with the meter such as LabSen™ 803 Pure Water pH Electrode. Contact us at 1-614-285-3080 or info@aperainst.com for more details. When testing purified water like spring water or drinking water, it will take longer for the readings to get stabilized (typically 3-5 minutes) because there is very few ions left to be detected by the sensor in those purified water.
- 2) Purified water such as distilled water and deionized water are recommended **for only** rinsing the probe for the best result.
- 3) The 201T-F pH Electrode is **NOT** suitable for testing high-temperature samples (>176°F). Testing high-temperature samples could cause permanent damage to the electrode. A specialized electrode such as LabSen™ 213 (up to 225°F) should be used in this situation.
- 4) The electrode housing is polycarbonate. When using cleaning solutions, take cautions on carbon tetrachloride, trichlorethylene, tetrahydrofuran, acetone, etc., which will dissolve the housing and invalidate the electrode.

5.3 Information regarding pH Calibration

5.3.1 Standard Buffer Solutions

The instrument adopts two series of standard buffer solutions: USA and NIST as shown in Table-4. Users can select which one to use in P1.1 (refer to section 7.3)

Table-4 pH Standard Buffer Series

Calibration Icons		pH Standard Buffer Series	
		USA Series	NIST Series
3 Points Calibration	Ⓐ	1.68 pH & 4.00 pH	1.68 pH & 4.01pH
	Ⓑ	7.00 pH	6.86 pH
	Ⓒ	10.01pH & 12.45 pH	9.18 pH & 12.45 pH

5.3.2 pH Calibration Modes

Users can adopt 1 to 3 points to calibrate as needed. In the 3-point calibration mode, the 1st point must be 7.00 pH (or 6.86 if using NIST). Then choose other calibration solutions to conduct 2nd and 3rd points (see Table-5 for details). In the process of calibration, the meter will display the electrode's slope in acid and alkaline ranges.

Table-5 3-point Calibration Mode

	USA	NIST	Calibration icon	When to adopt
1-Point Calibration	7.00 pH	6.86 pH	(M)	accuracy $\geq \pm 0.1$ pH
2-Point Calibration	7.00 pH → 4.00 pH or 1.68 pH	6.86 pH → 4.01 pH or 1.68 pH	(L) (M)	Measuring range: 0 to 7.00 pH
	7.00 pH → 10.01 pH or 12.45 pH	6.86 pH → 9.18 pH or 12.45 pH	(M) (H)	Measuring range: >7.00 pH
3-Point Calibration	7.00pH → 4.00 pH or 1.68 pH → 10.01pH or 12.45 pH	6.86pH → 4.01 pH or 1.68 pH → 9.18 pH or 12.45 pH	(L) (M) (H)	Wide measuring range

5.3.3 How often to calibrate

The frequency that you need to calibrate your meter depends on the tested samples, performance of electrodes, and the requirement of the accuracy. For High-Accuracy measurements ($\leq \pm 0.03$ pH), the meter should be calibrated before test every time; For ordinary-accuracy Measurements ($\geq \pm 0.1$ pH), once calibrated, the meter can be used for about a week or longer. In the following cases, the meter must be re-calibrated:

- The electrode hasn't been used for a long time or the electrode is brand new.
- After measuring strong acid (pH<2) or strong base (pH>12) solutions.
- After measuring fluoride-containing solution and strong organic solution
- There is a big difference between the temperature of the test sample and the temperature of the buffer solution that is used in the last calibration.

5.3.4 Calibration Reminder Function

Preset the interval between calibrations (starting from the time when you set it), and then the meter will remind you to calibrate at the end of that interval. For details, please see P1.2 (Section 7.3). When the (refer to section 7.3), preset time is reached, **Er6** icon will be displayed at the lower right corner of the LCD (as showed in Figure-8). At the time, the meter can still be operated. It is just reminding you to do calibration in order to ensure the accuracy. After calibration, the **Er6** icon will disappear; To make it disappear, users can also choose "No" in P1.2 in parameter setting.

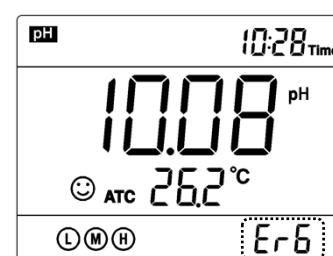

Figure-8

5.3.5 Check calibration date

In this mode, users can see the date and time of last calibration to help determine if there is a need to re-calibrate. For details, please see parameter setting P1.3 (Section 7.3)

5.3.6 pH Isothermal Measurement Principle

According to the pH isothermal measurement principle, the closer the test sample's temperature is

to the calibration solution's, the higher the accuracy of the measurement. This principle is recommended to follow when conducting tests for the best result. Example: If users were to test samples at 150°F, we recommend warming up the calibration solutions to the same temperature before performing calibrations in order to get the most accurate readings.

5.4 pH Calibration (Take 3-point calibration as an example)

5.4.1 Press **CAL** to enter calibration mode. CAL1 icon will flash in the upper right corner of the LCD. 7.00 pH will flash in the lower right corner of the LCD, reminding you to use pH 7.00 buffer to conduct 1st point of calibration.

5.4.2 Use distilled water to rinse off electrode and then dry it. Dip it into pH 7.00 buffer solution, stir gently and let it stand still and wait for the reading to become stable. In the lower right corner of LCD, the process of auto recognizing the buffer solution will be displayed. Pressing **ENTER** before the buffer is recognized will generate Er2 (please refer to table 6).

5.4.3 When the meter locks 7.00 pH, ☺ displays on LCD. Press **ENTER** key to calibrate the meter. **End** icon appears after calibration is done. The 1st point calibration is finished. In the meanwhile, CAL2 will flash at the upper right corner, and 4.00 pH & 10.01 pH will flash alternately at the bottom right, indicating using pH 4.00 or pH 10.01 buffer solution to make the 2nd point calibration.

5.4.4 Take out pH electrode, rinse it in distilled water, dry it, and dip it into pH 4.00 buffer solution. Stir the solution gently and let stand still in the buffer solution until a stable reading is reached. The meter's display will show the recognition process of calibration buffer solution at the lower right of LCD. When the meter recognizes 4.00 pH, ☺ displays on LCD. Press **ENTER** key to calibrate the meter. End icon and electrode slope of acidity range display after calibration is done. In the meanwhile, CAL3 will flash at the upper right corner of the LCD, and 10.01 pH will flash at the lower right, indicating using pH10.01 buffer solution to make the 3rd point calibration.

5.4.5 Take out pH electrode, rinse it in distilled water, dry it, and dip it into pH 10.01 buffer solution. Stir the solution gently and let it stand still in the buffer solution until a stable reading is reached. The meter's display will show recognition process of calibration buffer solution at the bottom right of LCD.

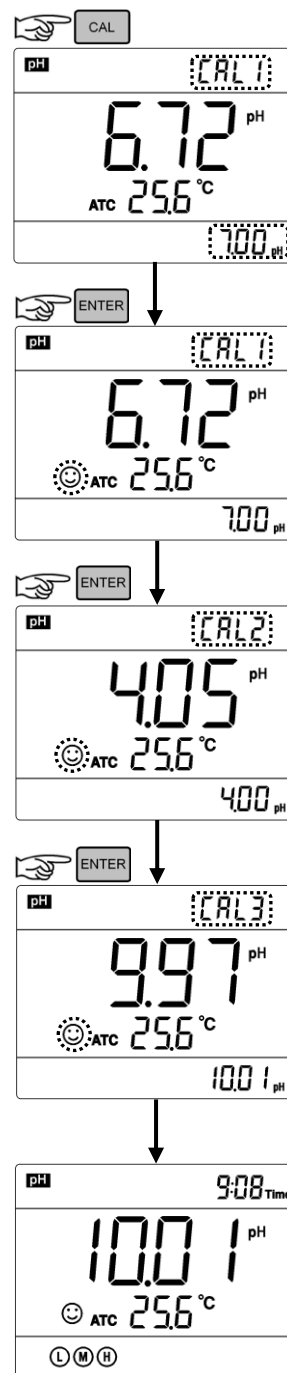

Figure-9

When the meter recognizes 10.01 pH, ☺ displays and stays on LCD. Press **ENTER** key to calibrate the meter. End icon and electrode slope of alkalinity range display after calibration is done. The meter returns to the measurement mode, displays stable measuring value and calibration guide icons **(L)** **(M)** **(H)** . Please see Figure-9 for the above calibration process.

5.5 Sample Measurement

5.5.1 Rinse the pH electrode in distilled water or distilled water, dry it, and dip it into sample solution. Stir the solution gently and let it stand still in the sample solution until ☺ icon appears and stays on LCD, get the pH reading, which is pH value of sample solution, please refer to Figure-10 for calibration and measurement process of the pH meter.

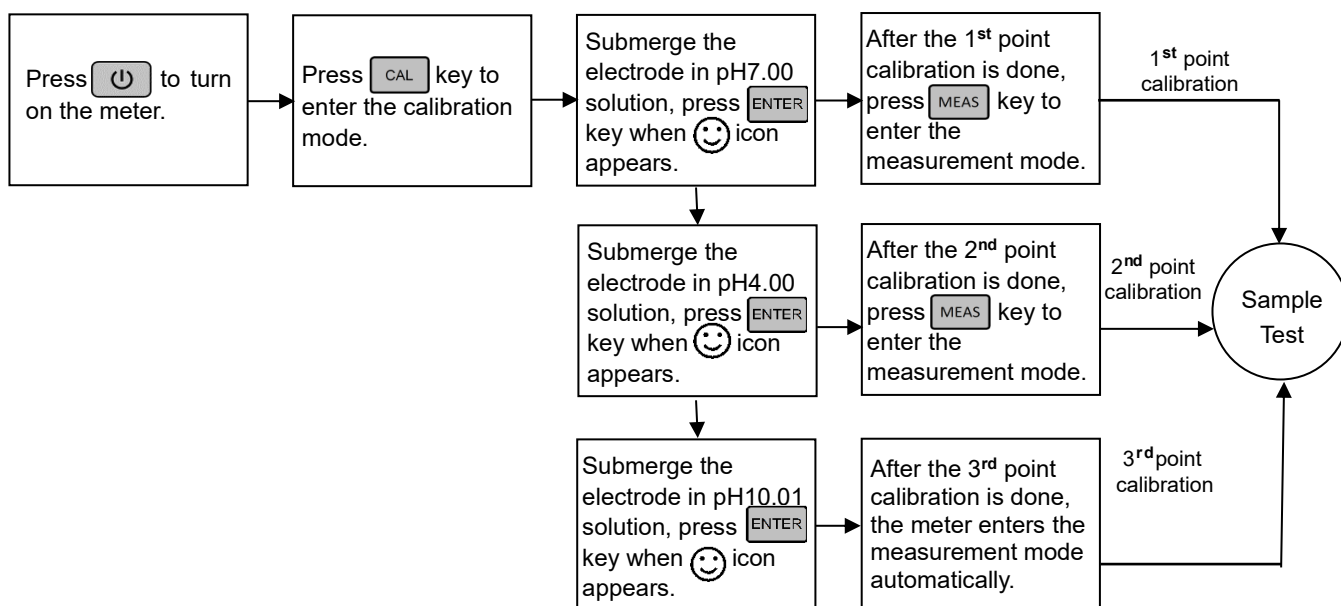



Figure-10

5.5.2 Self-Diagnosis Information

Among the calibration and measurement procedure, the meter has self-diagnosis function, reminding related information. Please refer to table-6.

Table – 6 Self-diagnosis information

Display Icons	Contents	Checking
<i>Er 1</i>	Wrong pH buffer solution or the buffer solution out of range.	<ol style="list-style-type: none"> 1. Check whether pH buffer solution is correct. 2. Check whether the meter connects the electrode properly. 3. Check whether the electrode is damaged.
<i>Er 2</i>	Press ENTER when reading is not stable during calibration.	Press ENTER key when ☺ icon appears and stays.

Er-3	During calibration, readings being unstable for over 3 minutes	<ol style="list-style-type: none"> 1. Check whether there are bubbles in glass bulb. 2. The pH Electrode is aged. Replace a new one.
Er-4	pH electrode zero electric potential out of range (<-60mV or >60mV)	<ol style="list-style-type: none"> 1. Check whether there are bubbles in glass bulb.
Er-5	pH electrode slope out of range (<85% or >110%)	<ol style="list-style-type: none"> 2. Check whether pH buffer solution is correct. 3. Check whether pH electrode is damaged. 4. The pH electrode is aged. Replace a new one
Er-6	The pre-set calibration due date is reached. Time to do perform a new calibration	Press  key to perform calibration or cancel due calibration setup in parameter P1.2.

*** If you find any air bubble in the glass bulb of the pH sensor, simply shake the probe for a few times to remove it. The existence of an air bubble in the glass bulb will significantly decrease the stability of measurement.**

5.5.3 The instrument has a function to return to factory default setting, which can be set up in P1.4 (refer to section 7.3). Returning to factory default setting is to restore the meter to theoretical value (zero potential pH is 7.00, slope is 100%), and set all the parameters to default settings (see appendix 1). When the meter's calibration or measurement is performing abnormally, users can use this function to let the meter return to factory default mode, and then conduct calibration and test again. Please note that this function is irreversible once used.

5.6 Maintenance of the pH Electrode

5.6.1 Daily maintenance

The soaking solution contained in the supplied protective bottle is used to maintain activation in the glass bulb and junction. Loosen the capsule, remove the electrode and rinse in distilled water before taking a measurement. Insert the electrode and tighten the capsule after measurements to prevent the solution from leaking. If the soaking solution is turbid or moldy, replace the KCL solution. Note: using other brands' storage solutions could cause permanent damage to the pH electrode because different chemicals are used. The electrode should not be soaked in distilled water, protein solution or acid fluoride solution for long periods of time. In addition, do not soak the electrode in organic lipids.

5.6.2 Calibration buffer solution

For calibration accuracy, the pH of the standard buffer solution must be reliable. The buffer solution should be refreshed often, especially after heavy use. We recommend 10-15 times of use before replacing the pH buffers.

5.6.3 Protect the glass bulb sensor

The sensitive glass bulb at the front of the combination electrode should not come in contact with hard surfaces. Scratches or cracks on the electrode will cause inaccurate readings. Before and after each measurement, the electrode should be washed with distilled water and dried. If a sample sticks to the electrode or it's contaminated, the electrode should be thoroughly cleaned using a soft brush and then rinsed with distilled water. After that, soak it in the KCL solution again for 6 hours.

5.6.4 Renew glass bulb

Electrodes that have been used over a long period of time will become aged. Submerge the electrode in 0.1mol/L hydrochloric acid for 24 hours, then wash the electrode in distilled water, then submerge it in KCL soaking solution for 24 hours. The method to prepare 0.1mol/L hydrochloric acid: dilute 9mL hydrochloric acid in distilled water to 1000mL. For serious passivation, submerge the bulb in 4% HF (hydrofluoric acid) for 3-5 seconds, and wash it in distilled water, then submerge it in the soaking solution for 24 hours to renew it.



5.6.5 Clean contaminated glass bulb and junction (please refer to Table-7)

Table-7 Clean contaminated glass bulb and junction

Contamination	Cleaning Solutions
Inorganic metal oxide	Dilute acid less than 1mol/L
Organic lipid	Dilute detergent (weak alkaline)
Resin macromolecule	Dilute alcohol, acetone, ether
Proteinic haematocyte sediment	Acidic enzymatic solution (saccharated yeast tablets)
Paints	Dilute bleach, peroxide

6 mV Measurement

6.1 mV Measurement

Press  to open, and press  to switch the meter to **mV** mode. mV mode is a mode for ORP and Ion electrode measurement. Connect ORP electrode (the 301Pt-C combination ORP electrode is sold separately) and dip it in sample solution, stir the solution briefly and allow it to stay in the solution until  icon appears and stays, then record the reading. ORP means Oxidation Reduction Potential. The unit is mV.

Connect Ion electrode and reference electrode to measure Ion electric potential.

6.2 Notes on ORP measurement

6.2.1 ORP measurement does not require calibration. When the user is not sure about ORP electrode quality or measuring value, use ORP standard solution to test mV value and see whether ORP electrode or meter works properly. Table-8 is the data of standard ORP solution for 222 mV.

Table-8 ORP Standard Buffer Solution (222mV±15mV , 25□)

°C	10	15	20	25	30	35	38	40
mV	242	235	227	222	215	209	205	201

6.2.2 Clean and activate ORP electrode

After the electrode has been used over a long period of time, the platinum surface will get polluted which causes inaccurate measurement and slow response. Please refer to the following methods to clean and activate ORP electrode:

- (a) For inorganic pollutant, submerge the electrode in 0.1mol/L dilute hydrochloric acid for 30 minutes, then wash it in distilled water, then submerge it in the soaking solution for 6 hours.
- (b) For organic or lipid pollutant, clean the platinum surface with detergent, then wash it in distilled water, then submerge it in the soaking solution for 6 hours.
- (c) For heavily polluted platinum surface on which there is oxidation film, polish the platinum surface with toothpaste, then wash it in distilled water, then submerge it in the soaking solution for 6 hours.

7 CONDUCTIVITY MEASUREMENT

7.1 Set up flexible Electrode Holder (refer to 4.1)

7.2 Information regarding the Conductivity Electrode

7.2.1 Conductivity electrode

EC800 and PC800 are equipped with model 2301T-F plastic conductivity electrode with constant K=1.0 and a built-in temperature sensor, which allows for automatic temperature compensation. The electrode housing is POM plastic which is corrosion resistant and impact resistant. When submerge the conductivity electrode in solution, stir the solution briefly to eliminate the air bubbles and improve response and stability.

7.2.2 Conductivity electrode constant

The meter matches conductivity electrodes of three constants: K=0.1, K=1.0 and K=10.0. Please refer to table-9 for measuring range. Set constant in parameter setting P2.1 and refer to clause 8.4

Table-9 Electrode constant and measuring range

Range	<20 $\mu\text{S/cm}$	1.0 $\mu\text{S/cm}$ to 100 mS/cm			>100 mS/cm
Conductivity electrode constant	K=0.1	K=1.0			K=10
Standard solution	84 $\mu\text{S/cm}$	84 $\mu\text{S/cm}$	1413 $\mu\text{S/cm}$	12.88 mS/cm	111.8 mS/cm
Electrode's model	DJST-0.1-F conductivity electrode	2301T-F conductivity electrode			2310T-F conductivity electrode

Note: When testing ultra-distilled water with conductivity less than 1.0 $\mu\text{S/cm}$, a flow test should be conducted in a flow cell.

* $1000 \mu\text{S/cm}^2 = 1 \text{mS/cm}^2$

7.3 Information regarding Conductivity Calibration

7.3.1 Conductivity Standard Calibration Solutions

The meter uses conductivity standard solution of 84 $\mu\text{S/cm}$, 1413 $\mu\text{S/cm}$, 12.88 mS/cm and 111.8 mS/cm . The meter can recognize the standard solution automatically, and can perform 1 to 4 points of calibration. The calibration indication icons correspond to the four standard values as shown in Table-10.

Table-10 Conductivity Calibration Solutions

Calibration Icons	Calibration Solutions
Ⓐ	84 $\mu\text{S/cm}$
Ⓑ	1413 $\mu\text{S/cm}$
Ⓒ	12.88 mS/cm
Ⓓ	111.8 mS/cm

7.3.2 How often to calibrate

- The meter has been calibrated before leaving the factory and can generally be used right out of the box.
- Normally perform calibration once per month.
- For high accuracy measurements or large temperature deviation from the reference temperature (25°C), perform calibration once per week.
- Use conductivity standard solution to check whether there is error. Perform calibration if error is large.
- For new electrode or the meter has been set to factory default, perform 3-point or 4-point calibration. For general use, choose standard solutions that are closer to the sample solution to perform 1-point or 2-point calibration.

7.3.3 Single point and multi-point calibration

If 1-point calibration is conducted after 3-point or 4-point calibration being done, the previous calibration values in the same range will be replaced. In the meanwhile, the meter will display the 1-point calibration's icon, and the other calibration icons will be removed, but the chip will still store the data from the last calibration. When conducting multi-point calibration, users should follow the sequence from low conductivity to high in case the high concentration solution contaminating the low ones.

7.3.4 Reference Temperature

The factory default setting for reference temperature is 25°C. The reference temperature can be set from 15°C to 30°C. Users can set it up in parameter setting P2.4 (see Section 7.4 for details).

7.3.5 Temperature compensation coefficient

The temperature compensation coefficient of the meter setting is 2.0%/°C. However, the conductivity temperature coefficient is different from solutions and concentration. Please refer to Table – 11 and the data collected during testing. Do the setting in P2.5. (see section 7.4 for more).

Note: When the coefficient for the temperature compensation is set to 0.00 (no compensation), the measurement value will be based on the current temperature.

Table-11 Temperature compensation coefficient of special solutions

Solution	Temperature compensation coefficient
NaCl solution	2.12%/°C
5% NaOH solution	1.72%/°C
Dilute ammonia solution	1.88%/°C
10% hydrochloric acid solution	1.32%/°C
5% sulfuric acid solution	0.96%/°C

7.3.6 Precaution for calibration solution's contamination

Conductivity standard solution has no buffer. Please pay attention not to contaminate the solutions during usage (especially for standard solution of low concentration like 84µS/cm). The contaminated standard solution will affect accuracy. Before submerging the electrode in standard solution, please rinse the electrode with distilled water and allow it to dry.

7.3.7 Calibration Reminder Setup

Preset the interval between calibrations (starting from the time when you set it), and then the meter will remind you to calibrate at the end of that interval. For details, please see P2.2 (Section 7.4). When the preset time is reached, **Er6** icon will be displayed at the lower right corner of

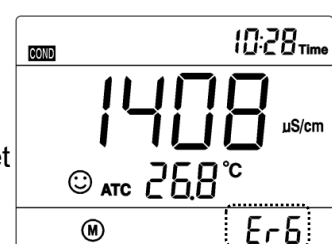

Figure-11



the LCD (as showed in Figure-11). At the time, the meter can still be operated. It is just reminding you to do calibration in order to ensure the accuracy. After calibration, the **Er6** icon will disappear; To make it disappear, users can also choose “No” in P2.2 in parameter setting.



7.3.8 Check calibration date

In this mode, users can see the date and time of last calibration to help determine if there is a need to re-calibrate. For details, please see parameter setting P2.3 (Section 7.4)

7.4 Conductivity Calibration (take 1413 $\mu\text{S}/\text{cm}^2$ as an example)

7.4.1 Rinse the electrode in distilled water, allow it to dry, wash with a little of standard solution and submerge it in 1413 $\mu\text{S}/\text{cm}$ standard solution. Stir briefly and allow it to stay in the solution until a stable reading is reached.

7.4.2 Press  key to enter the calibration mode. The meter’s display will show blinking—**CAL** at the top right, and scanning and locking process of calibration solution at the bottom right. **Er2** icon will appear if press  before value is stable. See table-6

7.4.3 When the meter locks 1413 μS , stable icon  will display on LCD. Press  key to complete calibration. End will appear and the meter will return to measuring mode and  is displayed on bottom left of the LCD screen. See figure-12.

7.4.4 Press  key before confirmation to exit calibration mode (calibration will not be completed).

7.4.5 For multi-point calibrations, please repeat the steps in 6.4.1 to 6.4.3 until all calibrations are finished. The meter can be calibrated in the same calibration solution repeatedly until the reading is stable and repeatable.

7.5 TDS, Salinity, Resistivity & Conductivity

7.5.1 TDS and conductivity is linear related. The conversion factor is 0.40-1.00. Adjust the factor from parameter P2.6. The factory default setting is 0.71 and please refer to section 7.4. Salinity and resistivity are all proportional to conductivity. The calculating formula is preset in the meter. So the meter only needs to be calibrated in Conductivity mode, then after calibration of conductivity, the meter can switch from conductivity to TDS, salinity, or resistivity.

7.5.2 Adjust TDS conversion factor in parameter setting P2.7 according to the data collected during

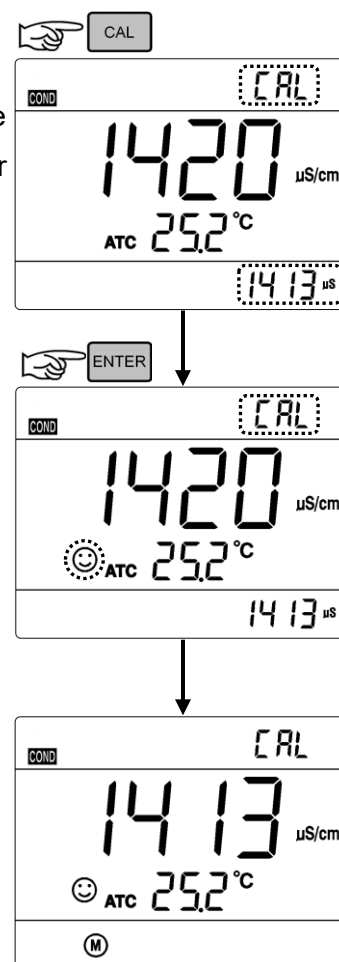

Figure-12

testing and experience. Table – 12 lists some commonly used Conductivity and TDS conversion factors. This is for your reference only.

Table-12 Conductivity and TDS conversion factors

Conductivity of solution	TDS conversion factor
0~100 $\mu\text{S/cm}$	0.60
100~1000 $\mu\text{S/cm}$	0.71
1~10 mS/cm	0.81
10~100 mS/cm	0.94

***1000 ppm = 1 ppt**





7.6 Sample Test

7.6.1 Rinse conductivity electrode in distilled water, dry it, and submerge it in the sample solution. Stir the solution briefly and allow it to stay in the sample solution until a stable reading is reached and  icon appears and stays on LCD, then get the reading, which is the conductivity value of the solution.

7.6.2 Press  key to switch to TDS, Salinity, and Resistivity.

7.6.3 During the process of calibration and measurement, the meter has self-diagnosis functions, indicating the relative information as below:

Table-13 Self-diagnosis information of conductivity measurement mode

Display Icons	Contents	Checking
<i>Er 1</i>	Wrong conductivity calibration solution or the meter recognition of calibration solution is out of range.	<ol style="list-style-type: none"> 1. Check whether conductivity calibration solution is correct. 2. Check whether the meter connects the electrode well. 3. Check whether the electrode is damaged.
<i>Er 2</i>	Press  key when measuring value is not stable during calibration.	Press  key after  icon appears and stays.
<i>Er 3</i>	During calibration, the measuring value being unstable for over 3 minutes.	<ol style="list-style-type: none"> 1. Shake the electrode to eliminate bubbles in electrode head. 2. Replace with new conductivity electrode.
<i>Er 6</i>	Enters pre-set due calibration to remind re-calibration	Press  key to perform calibration or cancel due calibration setup in parameter P2.2.

7.6.4 Factory default setting

For factory default setting, please refer to parameter setting P2.7 (Section 7.4). With this function,

all calibration data is deleted and the meter restores to the theory value. Some functions restore to the original value (refer to appendix -1). When calibration or measurement fails, please restore the meter to factory default setting and then perform re-calibration or measurement. Please note once set the factory default, all the data deleted will be irretrievable.

7.7 Maintenance of the Conductivity Electrode

7.7.1 Always keep the conductivity electrode clean. Before taking a measurement, rinse the electrode in distilled water. It is recommended to rinse it again in the sample solution. When submerge the electrode in solution, stir the solution briefly to eliminate air bubbles and allow it to make the measurement fast and stable.

7.7.2 At the top of the electrode there is a water sponge (see figure-13), when water sponge is dry up, please refill with distilled water to keep it wet (not too much). Keep in wet condition helps the electrode's fast response time. Electrode may react slowly if kept dry for a long period. Submerge it in 12.88Ms buffer solution for 5 to 10 minutes or in tap water for 1 to 2 hours to renew it. Use distilled water to clean electrode after use.

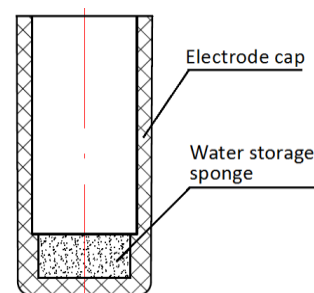

Figure-13

7.7.3 The sensing rod of Model 2301T-F conductivity electrode is coated with platinum black to minimize electrode polarization and expand measuring range. The platinum black coating adopted our special processing technology, which improves the electrode performance and the firmness of the coating. If the platinum black electrode is stained, gently clean the electrode with soft brush in warm water containing detergent or alcohol.

8 PARAMETER SETTING

8.1 Main Menu

In the measurement mode, press **MODE SETUP** key to enter in P1.0, then press **▲** or **▼** to switch main menu: P1.0→P2.0→P5.0. Please refer to Figure - 14.

P1.0: pH parameter setting menu,

P2.0: Conductivity parameter setting menu,

P5.0: Basic parameter setting menu.

8.2 Sub-Menu

7.2.1 In P1.0, press **ENTER** to enter the submenu P1.1 for pH setting, press **▲** and **▼** to change submenu: P1.1→P1.2→ ... →P1.4. See 7.3 for details.

7.2.2 In P2.0, press **ENTER** to enter the submenu P2.1 for conductivity setting, press **▲** and **▼**

to change submenu: P2.1→P2.2→ ... →P2.7. See 7.4 for details.

7.2.3 In P5.0, press **ENTER** to enter the submenu P5.1 for basic parameter setting, press **▲** and **▼** to change submenu: P5.1→P5.2→...→P5.6. See 7.5 for details.

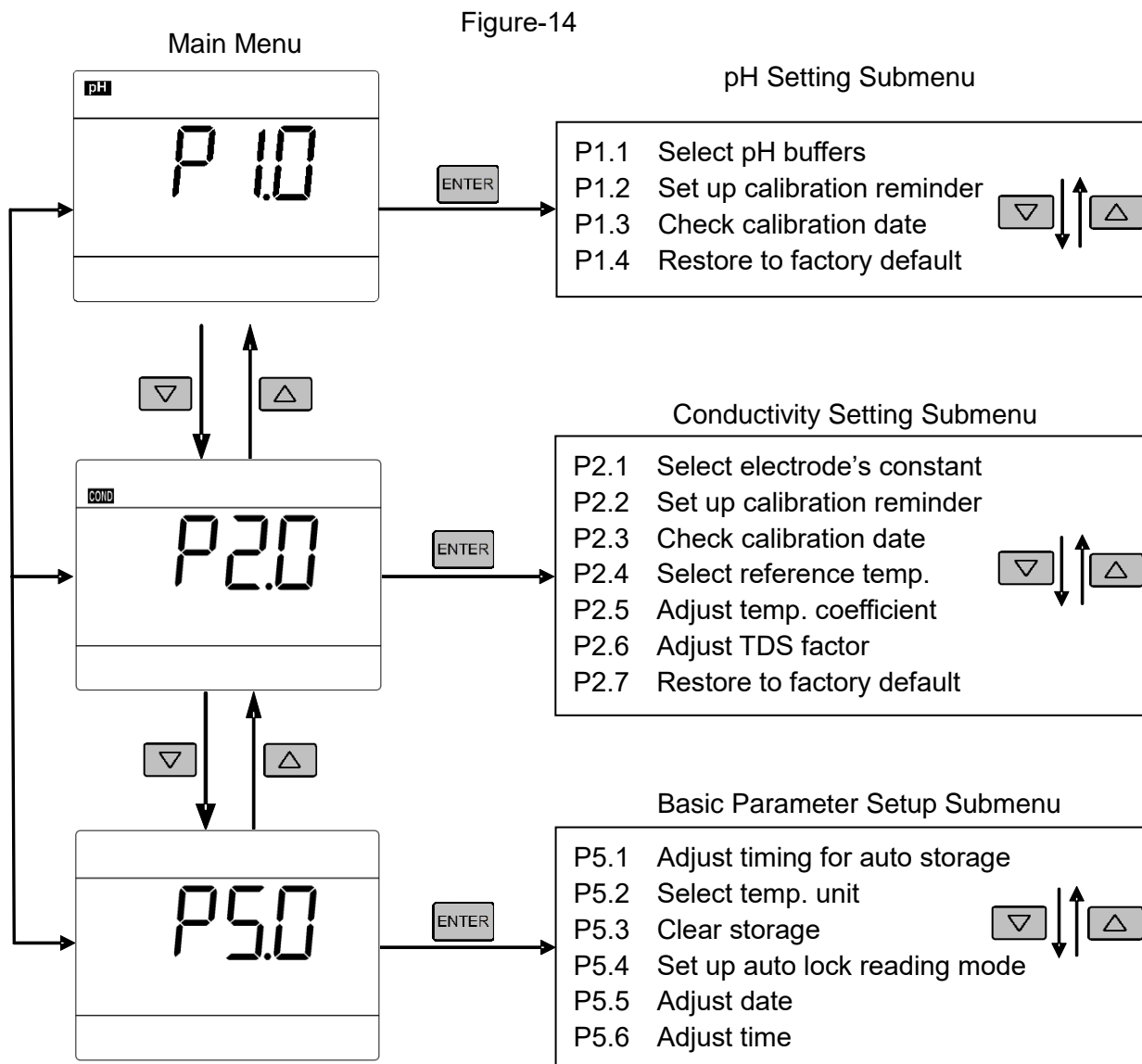

8.3 pH Setting Sub-Menu (press **▲** or **▼** to switch)

<div style="border: 1px solid black; padding: 5px;"> <p style="text-align: center;">pH buf</p> <p style="font-size: 2em; text-align: center;">P 1.1</p> <hr/> <p style="text-align: center;">USA</p> </div>	<p>P1.1 — Select pH buffer series (USA—NIST)</p> <ol style="list-style-type: none"> 1. In measurement mode, long press MODE SETUP to enter P1.0, press ENTER to enter P1.1 2. Press ENTER, USA flashes, press ▲ to choose USA→NIST, press ENTER to confirm. USA—USA ; NIS—NIST 3. Press ▲ to enter P1.2, or press MEAS to return to measurement mode.
--	--

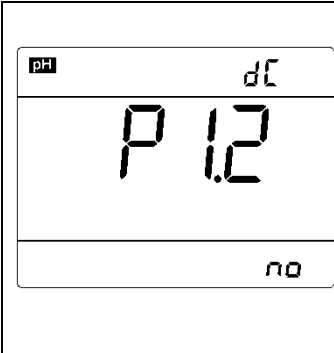
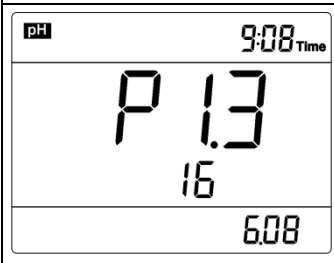
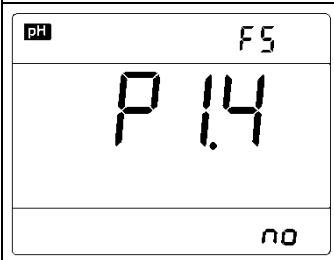
	<p>P1.2 — Set up calibration reminder (No—H00—D00)</p> <ol style="list-style-type: none"> 1. Press ENTER, "No" flashes, press △ to choose No→H00→D00 ; NO—no setting; H00—set hours(0~99); D00—set days(0~99). 2. When "H" flashes, press ENTER, "00" flashes, press △ to adjust hours, press ENTER to confirm; When "D" flashes, press ENTER, "00"flashes, press △ to adjust days, press ENTER to confirm; When "No" flashes, press ENTER to confirm. 3. Press △ to enter P1.3, or press MEAS to return to measurement mode.
	<p>P1.3 — Check Calibration Time</p> <ol style="list-style-type: none"> 1. The data and time of last calibration displayed on the left image is: On June 8, 2016 to 9:08 2. Press △ to enter P1.4, or press MEAS to return to measurement mode.
	<p>P1.4 — Set the Factory Default (No—Yes)</p> <p>Press ENTER, "NO" flashes, press △ to select NO→Yes, press ENTER to confirm, instrument back to measurement mode.</p> <p>No — Not restore; Yes — Restore factory default</p>

8.4 pH Setting Sub-Menu (press **△ or **▽** to switch)**

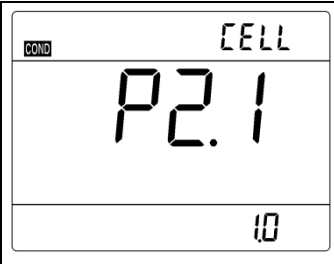
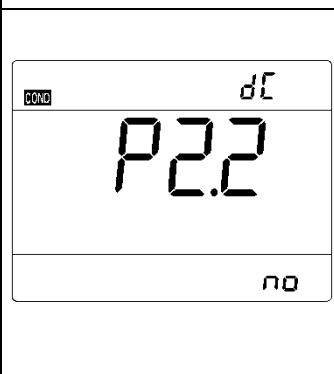
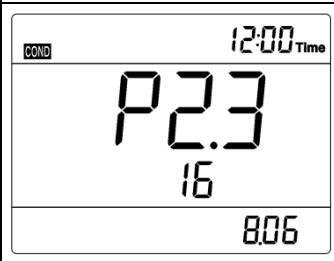
	<p>P2.1 — Select electrode's constant (1.0—10.0—0.1)</p> <ol style="list-style-type: none"> 1. In P2.0, press ENTER to enter P2.1 2. Press ENTER "1.0" flashes, press △ to choose 1.0→10.0→0.1; press ENTER to confirm. 3. Press △ to enter P2.2, or press MEAS to return to measurement mode.
	<p>P2.2 — Set up calibration reminder (No—H00—D00)</p> <ol style="list-style-type: none"> 1. Press ENTER, "No" flashes, press △ to choose No→H00→D00 ; NO—no setting; H00—set hours(0~99); D00—set days(0~99). 2. When "H" flashes, press ENTER, "00" flashes, press △ to adjust hours, press ENTER to confirm; When "D" flashes, press ENTER, "00"flashes, press △ to adjust days, press ENTER to confirm; When "No" flashes, press ENTER to confirm. 3. Press △ to enter P2.3, or press MEAS to return to measurement mode.
	<p>P2.3 — Check Calibration Time</p> <ol style="list-style-type: none"> 1. The data and time of last calibration displayed on the left image is: On August 6, 2016 to 12:00. 2. Press △ to enter P2.4, or press MEAS to return to measurement mode.

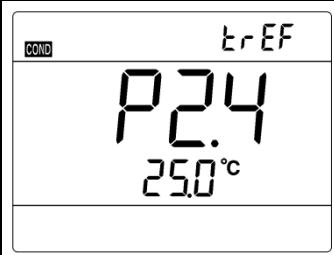
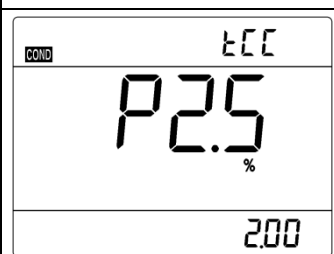
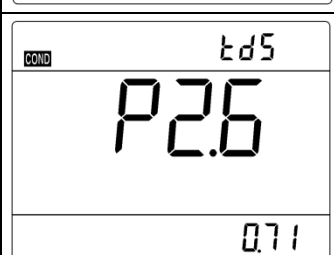
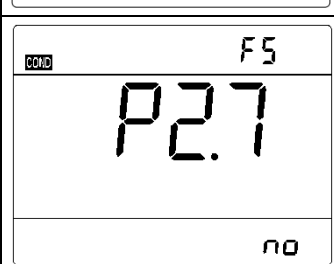
	<p>P2.4 —Select reference temperature (15.0□—30.0□)</p> <ol style="list-style-type: none"> 1. Press ENTER , “25.0°C” flashes, press ▲ or ▼ to adjust temp. from 15°C to 30°C; press ENTER to confirm. 2. Press ▲ to enter P2.5, or press MEAS to return to measurement mode.
	<p>P2.5 —Adjust temp. compensation coefficient (0.00-9.99%)</p> <ol style="list-style-type: none"> 1. Press ENTER , “2.00” flashes, press ▲ or ▼ to adjust from 0.00-9.99; press ENTER to confirm. 2. Press ▲ to enter P2.6, or press MEAS to return to measurement mode.
	<p>P2.6 —Adjust TDS Factor (0.40-1.00)</p> <ol style="list-style-type: none"> 1. Press ENTER , “0.71” flashes, press ▲ or ▼ to adjust from 0.40-1.00; press ENTER to confirm. 2. Press ▲ to enter P2.7, or press MEAS to return to measurement mode.
	<p>P2.7 — Set the Factory Default (No—Yes)</p> <p>Press ENTER , “No” flashes, press ▲ to select No→Yes, press ENTER to confirm, instrument back to measurement mode.</p> <p>No — Not restore; Yes — Restore factory default</p>

8.5 Basic Parameter Setting Sub-Menu (press **▲ or **▼** to switch)**

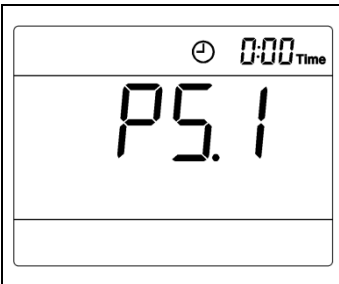
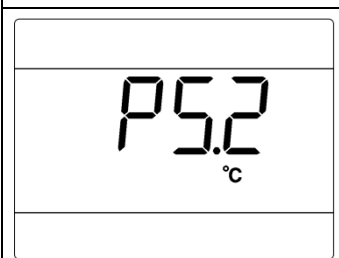
	<p>P5.1 — Adjust timing for auto storage</p> <ol style="list-style-type: none"> 1. In P5.0, press ENTER to enter P5.1 as shown in the left figure. 2. Press ENTER , “:00” flashes, press ▲ or ▼ to set minute (0-59), press ENTER again, “0:” flashes, press ▲ or ▼ to set hours (0-99), press ENTER to confirm. 3. Press ▲ to enter P5.2, or press ENTER to return to measurement mode.
	<p>P5.2 — Choose Temp. Parameter (°C—°F)</p> <ol style="list-style-type: none"> 1. Press ENTER , “°C” flashes, press ▲ to choose °C→°F, press ENTER to confirm. 2. Press ▲ to enter P5.3, or press MEAS to return to measurement mode.

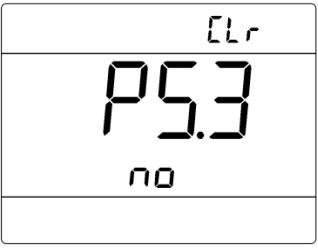
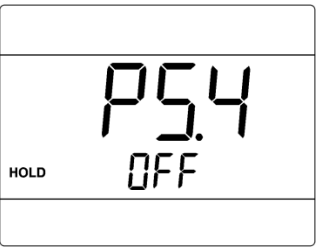
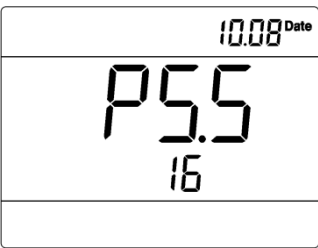
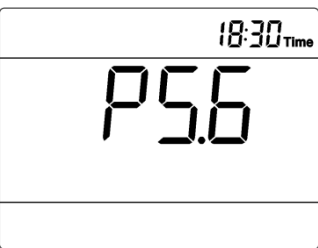
	<p>P5.3 — Clear storage (No—Yes)</p> <ol style="list-style-type: none"> 1. Press ENTER , “No” flashes, press △ to choose No→Yes; press ENTER to confirm. No— not to clear data storage; Yes—clear all data storage 2. Press △ to enter P5.4, or press MEAS to return to measurement mode.
	<p>P5.4 — Set up Auto-Lock reading mode (Off—On)</p> <ol style="list-style-type: none"> 1. Press ENTER , “Of” flashes, press △ to choose Off→On, press ENTER to confirm. Off— not set up, On—set up 2. Press △ to enter P5.5, or press MEAS to return to measurement mode.
	<p>P5.5 — Adjust Date</p> <ol style="list-style-type: none"> 1. Press ENTER to choose “Month”→ “Day”→ “Year”, press △ or ▽ to adjust date, press ENTER to confirm. 2. Press △ to enter P5.6, or MEAS press to return to measurement mode.
	<p>P5.6— Adjust Time</p> <ol style="list-style-type: none"> 1. Press ENTER to choose — “hour”→ “minute”, press △ or ▽ to adjust time, press ENTER to confirm. 2. Press MEAS to return to measurement mode.

9 USB DATA COMMUNICATION

The instrument uses PC-Link software for data communication through USB connector and cable.

9.1 Software Interface

Figure- 15

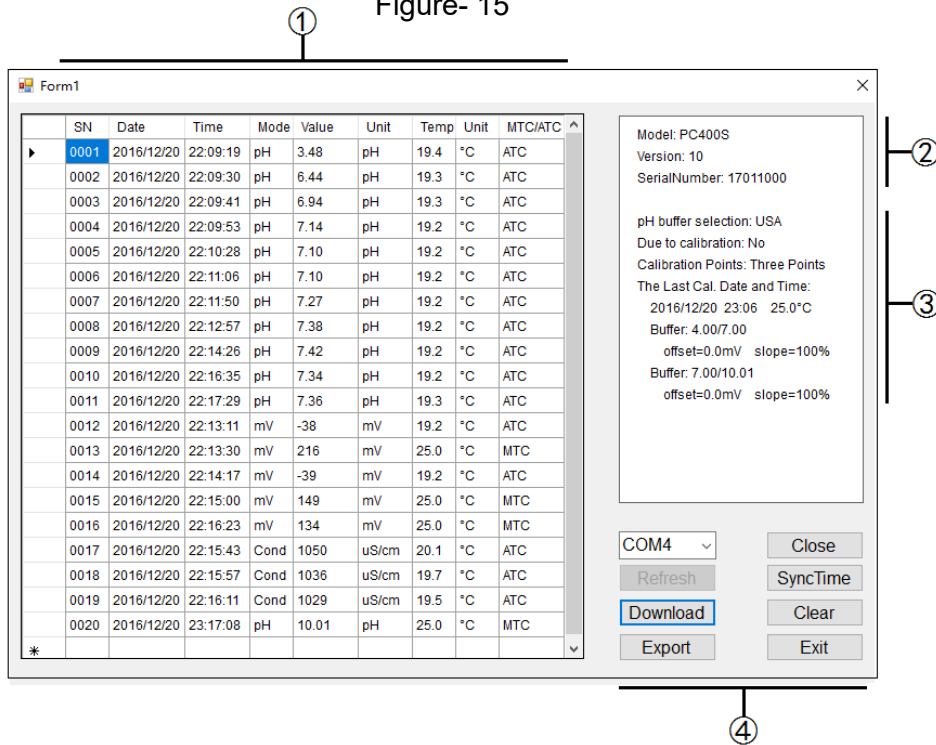

① — Stored data

(a) Press “Download” Key to upload the data in the meter to the software, including date, time, measurements, temperature, and temperature compensation mode. The program will categorize the data by pH, mV, and Cond.

(b) Press **M+/RM** after the meter is connected to the computer, or set up auto timing storage function. In this case, all the measuring data will be uploaded to the software, and will not be stored in the meter. See figure-15.

② — Model and Numberings

③ — Calibration information

④ — COM Port #and other buttons

COM Port # is the number for the software to connect with the computer. Every computer’s COM port is different. In Figure-15, the COM port # is COM4.

- Open/Close — Click it to turn on/off the program. When turned on, the LCD will display 
- Refresh — COM port reset button; Click it to reset the COM port to COM1.
- Sync Time — Click it to sync the computer’s time and date to the meter’s.

- Download — Click it to upload the data stored in the meter to the computer.
- Clear — Click it to clear all the data.
- Export — Click it to export all the data to a Microsoft Excel file.
- Exit — Click it to exit the program.

9.2 Install software

The PC-Link software works for all Windows based system (does not work for Mac). Insert the PC-Link disk into the computer, open the PC-Link folder where you will find the folder for PC-Link software and a zipped file for drivers. Typically, users can directly open the file with PC-Link icon to use the software. If the meter cannot be connected to the computer, please install the USB driver (in the zipped file) before using the software.

9.3 Choose COM Port



Connect the meter to your computer with the USB cable. Open the PC-Link program. click the arrow icon next to the COM1 Port, and click the bottom port number, and then click Open. The LCD will display  icon. If port number is hard to be confirmed, users can identify it in Windows' Device Manager.

9.4 Run Software

9.4.1 Upload stored data

Click Download key to upload the data stored in the meter to the software, including date, time, measurements, temperature, and temperature compensation mode. The program will categorize the data by pH, mV, and Cond.

9.4.2 Real-time storage

- When the program is running and meter is connected to computer, press  on the meter or set up auto timing storage to upload all the measuring data to the software. The data will not be stored in the meter in this mode.
- The mode and unit for real-time storage is the same as it is in the meter. Press  or  to make changes.

9.4.3 Data Processing

Click "Export" to export all the data to a Microsoft Excel file. Users can process, analyze, and print the data in the Excel file.

10 RECOMMENDED PH ELECTRODES FOR SPECIFIC APPLICATIONS

Application	Ideal Apera pH Electrodes to Use with PH800 Meter
Regular water solutions	201T-F, LabSen 213
Beverage, beer, or wine analysis	LabSen 213
Cosmetics	LabSen 851-1, (MP500 temp. probe required)
Dairy products (milk, cream, yogurt, mayo, etc.)	LabSen 823
High-Temperature liquid	LabSen 213
Low-temperature liquid	LabSen881 (MP500 temp. probe required)
Meat	LabSen 763
Micro sample testing	LabSen 241-6, LabSen 241-3 (MP500 temp. probe required)
Purified Water (Low ion concentration samples)	LabSen 803, LabSen 813
Soil	LabSen 553
Solid or semi-solid samples (cheese, rice, fruit, etc.)	LabSen 753
Strong acid samples	LabSen 831 (MP500 temp. probe required)
Strong alkalined samples	LabSen 841 (MP500 temp. probe required)
Surface test (skin, paper, carpet, etc.)	LabSen 371 (MP500 temp. probe required)
Titration	LabSen 223
TRIS buffer solutions	LabSen 213, LabSen 223
Viscous liquid samples	LabSen 223, LabSen851-1
Wastewater or emulsion	LabSen 333

11 WARRANTY

We warrant this instrument to be free from defects in material and workmanship and agree to repair or replace free of charge, at option of APERA INSTRUMENTS(Europe) GmbH, any malfunctioned or damaged product attributable to responsibility of APERA INSTRUMENTS(Europe) GmbH for a period of TWO YEARS (SIX MONTHS for the probe) from the delivery.

This limited warranty does not cover any damages due to:

Transportation, storage, improper use, failure to follow the product instructions or to perform any preventive maintenance, modifications, combination or use with any products, materials, processes, systems or other matter not provided or authorized in writing by us, unauthorized repair, normal wear and tear, or external causes such as accidents, abuse, or other actions or events beyond our reasonable control.

12 APPENDIX 1: TABLE OF PARAMETER SETTING AND FACTORY DEFAULT SETTING

Mode	Symbol	Parameter	Abbreviation	Content	Factory Default
P1.0 pH	P1.1	Select Buffer Series	buF	USA - NIST	-
	P1.2	Set calibration reminder	dC	No - H00 - D00	No
	P1.3	Check calibration date and time	/	-	-
	P1.4	Restore factory default	FS	No - Yes	No
P2.0 Conductivity	P2.1	Select electrode's constant	CELL	1.0 - 10.0 - 0.01	1.0
	P2.2	Set calibration reminder	dC	No - H00 - D00	No
	P2.3	Check calibration date and time	/	-	-
	P2.4	Select reference temperature	tREF	15~30°C	25°C
	P2.5	Adjust temperature compensation coefficient	tCC	0.00~9.99	2.00%
	P2.6	Adjust TDS factor	tDS	0.40~1.00	0.71
	P2.7	Restore factory default	FS	No - Yes	No
P5.0 Basic Parameter	P5.1	Adjust timing for auto storage	/	-	-
	P5.2	Select temperature unit	/	°C - °F	-
	P5.3	Clear data storage	CLr	No - Yes	-
	P5.4	Set up auto-lock reading mode	/	Off—On	-
	P5.5	Adjust date	/	-	-
	P5.6	Adjust time	/	-	-

13 APPENDIX 2: ICONS AND ABBREVIATION

Mode	Symbol	Abbreviation	Meaning
P1.0 pH	P1.1	buF	Standard buffers
	P1.2	dC	Due Calibration
	P1.3	/	
	P1.4	FS	Factory default setting
P2.0 Conductivity	P2.1	CELL	Cell
	P2.2	dC	Due Calibration
	P2.3	/	
	P2.4	trEF	Reference temperature
	P2.5	tCC	Temperature compensation coefficient
	P2.6	tDS	TDS coefficient
	P2.7	FS	Factory default setting
P5.0 Basic Parameter	P5.1	/	
	P5.2	/	
	P5.3	CLr	Clear readings
	P5.4	/	
	P5.5	/	
	P5.6	/	
Others		USA	United States of America
		n IS	NIST
		OFF	Off
		On	On
		no	No
		YES	Yes

14 APPENDIX 3: TABLE OF SELF-DIAGNOSIS SYMBOL

Symbol	Self-Diagnosis Information	pH	Conductivity
<i>Er 1</i>	Wrong calibration solution or the meter recognition of calibration solution out of range.	✓	✓
<i>Er 2</i>	Press  key when measuring value is not stable during calibration.	✓	✓
<i>Er 3</i>	During calibration, the measuring value is not stable for ≥ 3 min.	✓	✓
<i>Er 4</i>	pH electrode zero electric potential out of range (<-60mV or >60mV)	✓	
<i>Er 5</i>	pH electrode slope out of range (<85% or >110%)	✓	
<i>Er 6</i>	Enter in pre-set due calibration to remind re-calibration	✓	✓

APERA INSTRUMENTS (Europe) GmbH
 Wilhelm-Muthmann-Straße 15
 42329 Wuppertal Germany
 Email: info@aperainst.de
 Website: www.aperainst.de
 Tel. +49 202 51988998